

Saw blade, circular saw blade width 0.3 mm (0.011")

Technical data

TH accessories category	Circular saw blade d50
Tool mounting	13mm

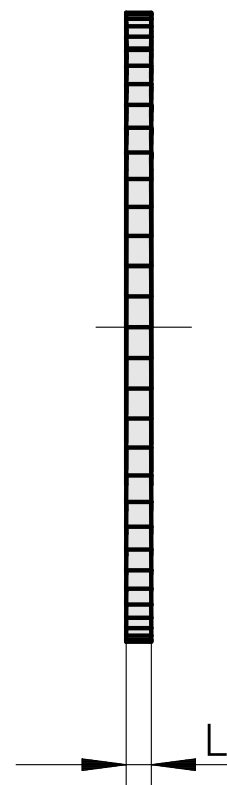
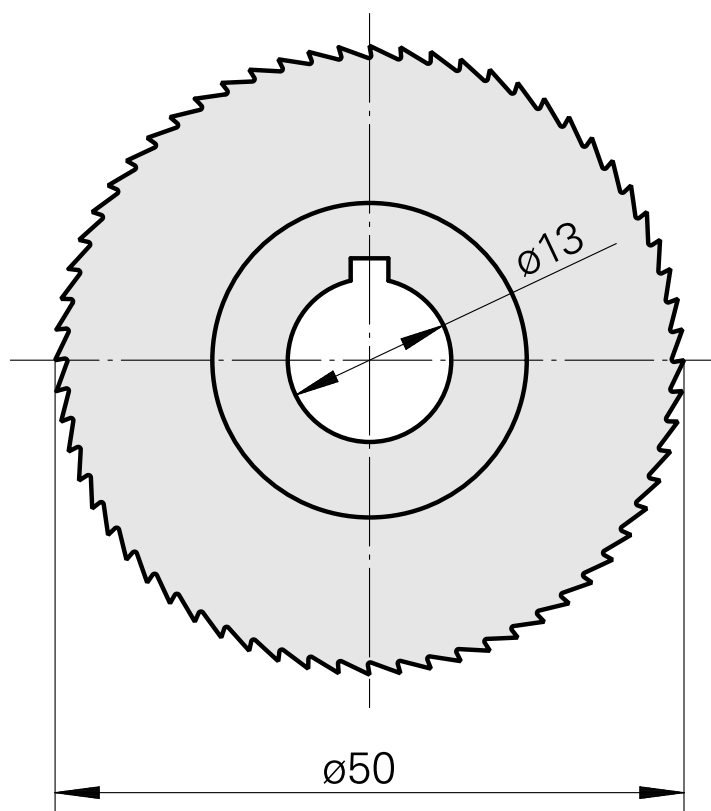
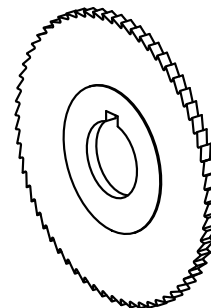

11053739
223010.5003

INDEX

Documents

No downloads available for this product