

## Grooving tool holder KPS 45 Trapezoid 32

### Technical data

<b>Shank KPS</b>	KPS 45
<b>Drive</b>	not live
<b>Cooling</b>	internal
<b>Mounting</b>	Trapezoid 32x8
<b>Pressure</b>	80 bar
<b>X [mm]</b>	68 (2.68")
<b>Y [mm]</b>	-
<b>Z [mm]</b>	-6 (-0.24)
<b>INDEX TRAUB products</b>	TNL18 • TNL20 • TNL32-11 • TNL32 • TNL32-11 compact • TNL20-11 • TNL32 compact • TNK40.2-10 • TNL20.2 • TNK40.2

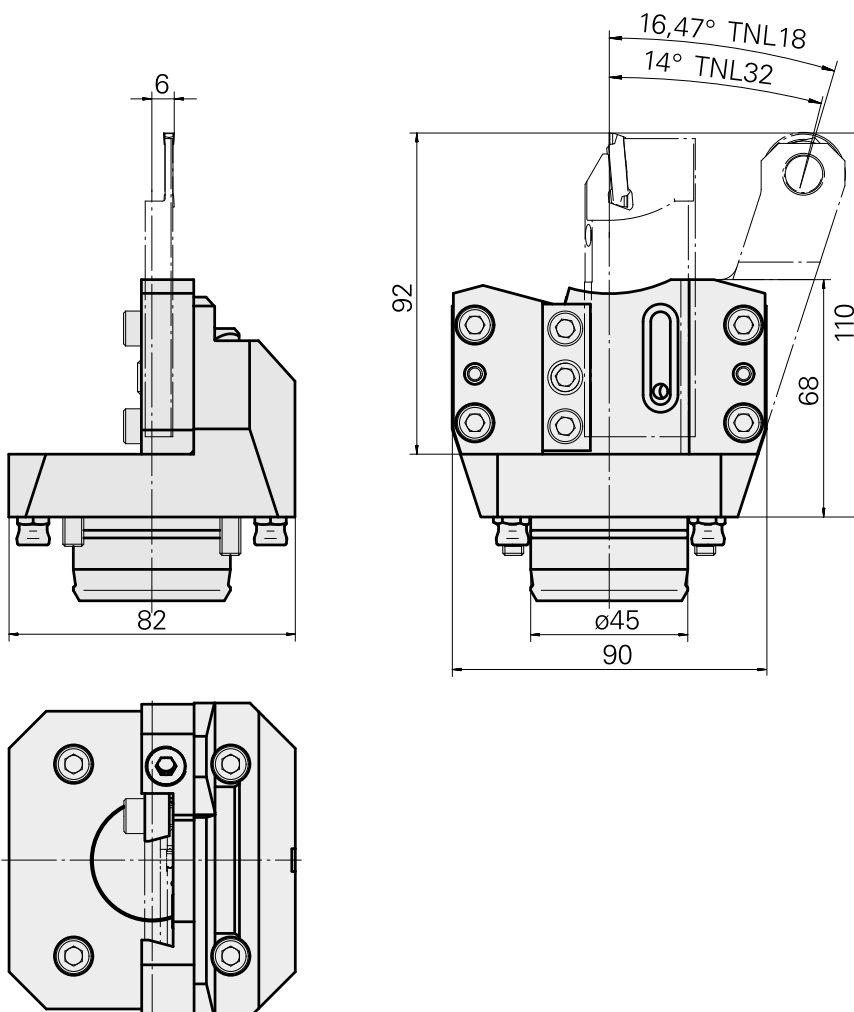
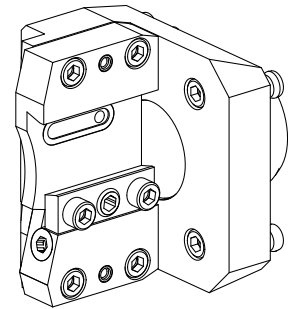

---

## Documents

No downloads available for this product

## Accessories

### Optional accessories

#### O-Rings

#### [Gasket ring OR 18,77X1,78](#)

Product ID : 10897583

Previous product ID : 316038

manufacturer product line Trelleborg	TSS material no.	Cord size 1.78 Millimeter	manufacturer product line O-ring
---	------------------	------------------------------	-------------------------------------

#### Tool holders with compact shank

#### [Bar stop, live](#)

Product ID : 10436606

Previous product ID : W9990516

Drive not live	INDEX TRAUB products TNL32-11 compact • TNL32 • TNL20-11 • TNL32 compact • TNK40.2-10 • TNL20 • TNL32-10 • TNL32-11 • TNL32-7 • TNL32-7B • TNL32-8 • TNL32-9 • TNL32-9P • TNL32P • TNL20.2 • TNK40.2
-------------------	---

#### Other accessories

#### [Bush 4x8x12](#)

Product ID : 10831938

Previous product ID : W02010.0002

---

#### [Hollow screw M12x1](#)

Product ID : 10757766

Previous product ID : W02013.0001

---

10958857  
W7040097

**INDEX**

---

[Nozzle Kugel-D8](#)

Product ID : 10007891  
Previous product ID : 904837

---

[Locking screw M12x1](#)

Product ID : 10135400  
Previous product ID : 910677

---