

## WFB 32-20 Milling shaft D16

### Technical data

TH accessories category

WFB 32-20

Mounting

Milling shaft D16

Quick change inserts

mill arbor mounting

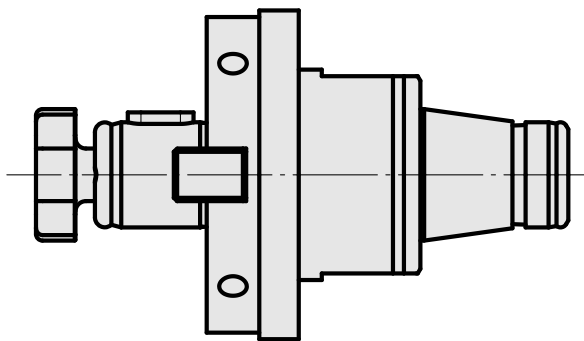
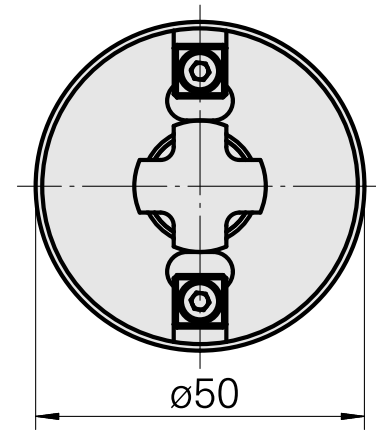
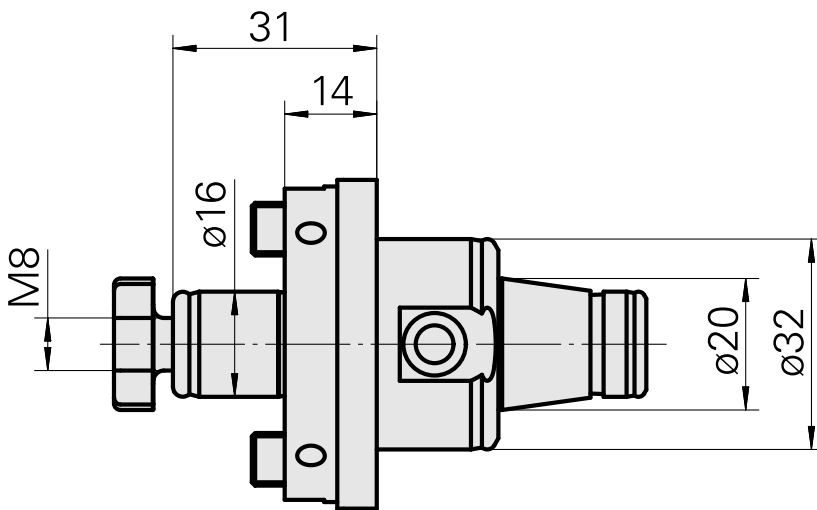
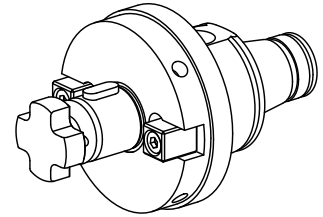

---

## Documents

No downloads available for this product

## Accessories

Required for operation

### [mill arbor wrench](#)

Product ID : 10007866

Previous product ID : 203020.1160

TH accessories  
category  
Tool

Mounting  
Milling shaft D16

Tools for Collet chucks  
Mill arbor wrench

### Optional accessories

#### Tool holder accessories

### [Screw](#)

Product ID : 10381768

Previous product ID : 250122.0820

TH accessories  
category  
Cutter tightening screw

Mounting  
M8

#### Other accessories

### [Ring](#)

Product ID : 10398855

Previous product ID : 251390.----

---

### [Ring](#)

Product ID : 10169490

Previous product ID : 251391.----

---