

Drilling tool holder Shank 40 D10 (0.39)

Technical data

Shank TNL	Shank 40
Drive	not live
Cooling	internal
Pressure	120 bar
Mounting	D10
INDEX TRAUB products	TNK36 • TNL26

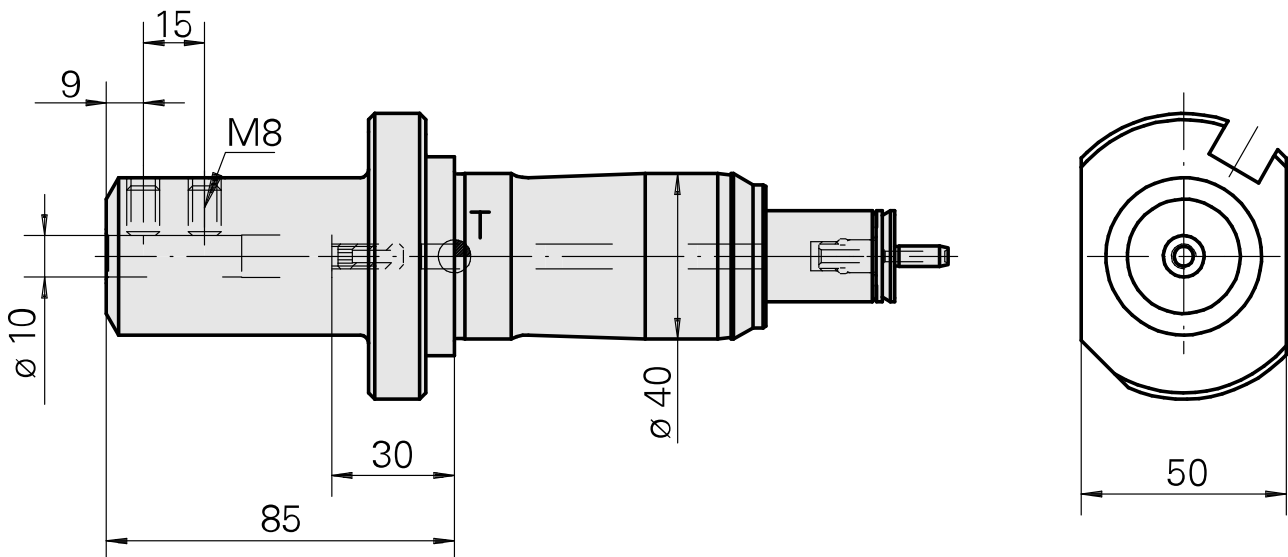
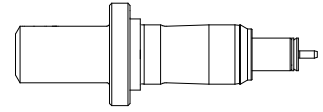

10835923
835255

INDEX

Documents

No downloads available for this product