

WFB 32-20 Shrink-fit mounting D4

Technical data

TH accessories category

WFB 32-20

Mounting

Shrink-fit mounting D4

Quick change inserts

shrink-fit mounting

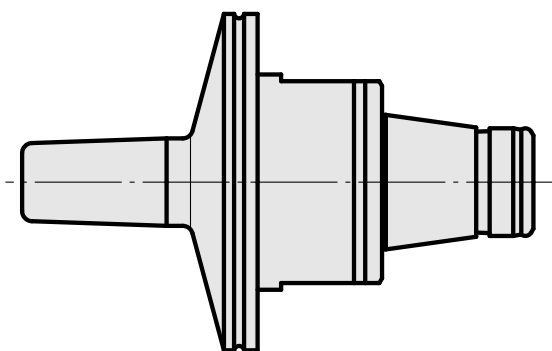
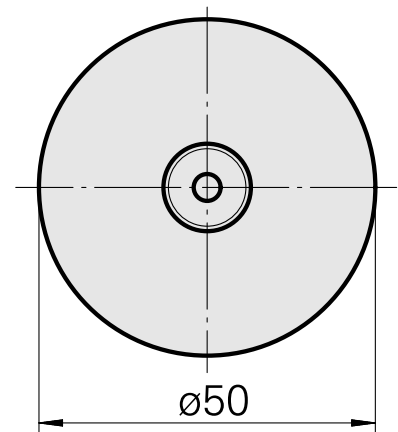
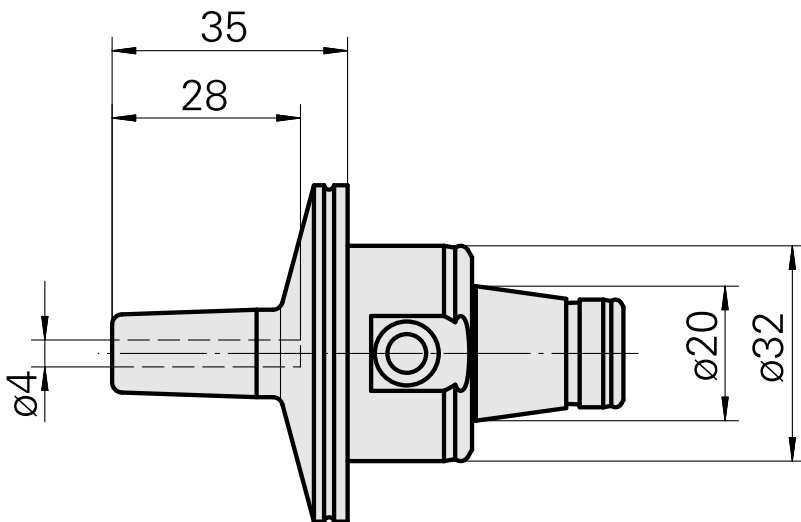
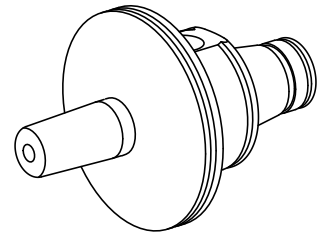

10802134
836261

INDEX

Documents

No downloads available for this product