

ER-Collet chuck for taps ET 1-25 6mm

Technical data

TH accessories category	ER-Collet chuck for taps
Mounting	ER25
Tool mounting	6mm
Collet type	ET 1-25

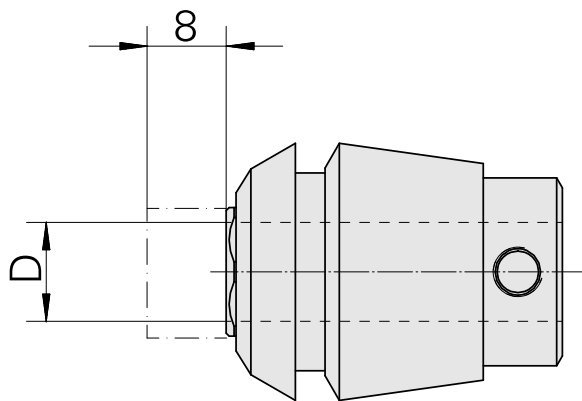

10730338
322463

INDEX

Documents

No downloads available for this product