

Plate, height 4 mm (0.15")

Technical data

TH accessories category

Compensation plate

Mounting

Square 20x20

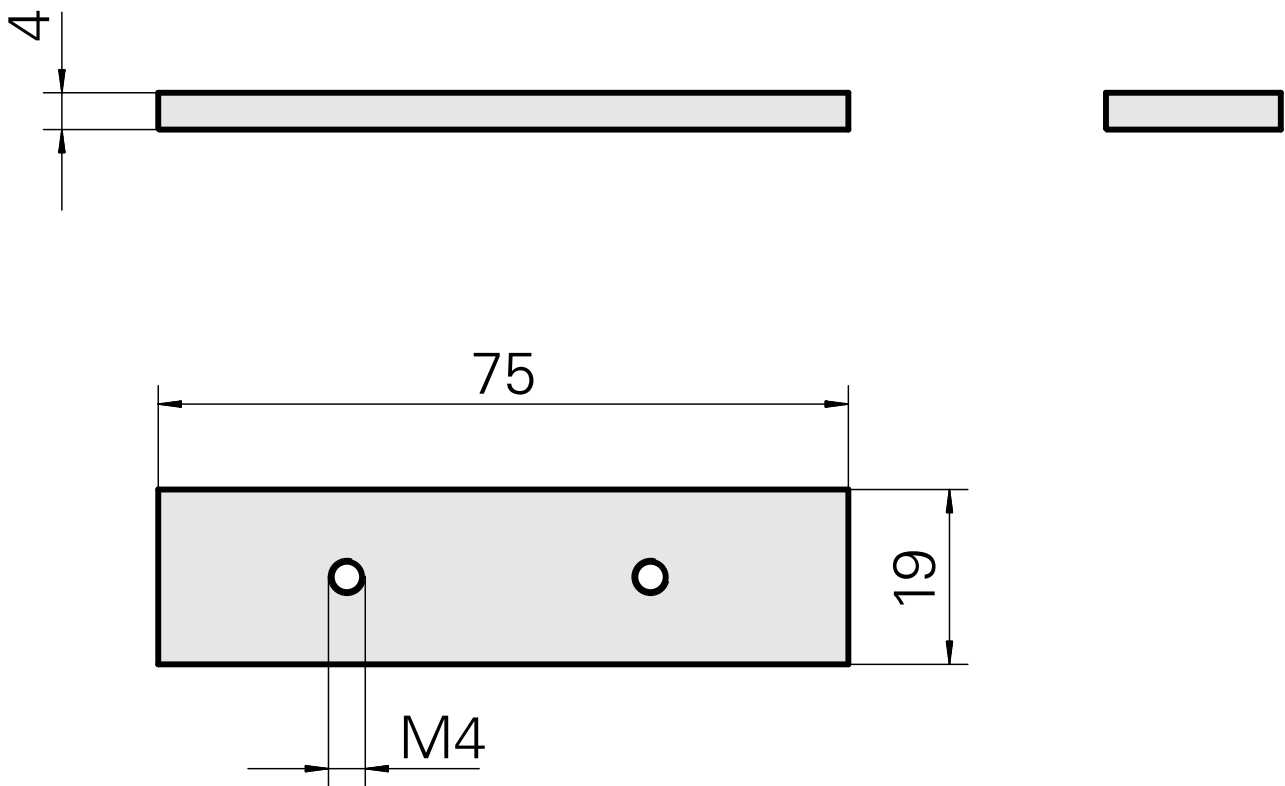
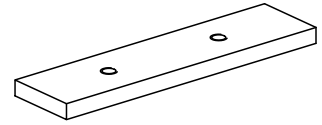

Documents

No downloads available for this product