

## Bague, largeur 0,5 mm

### Données techniques

Catégorie d'accessoires PO

Bague porte-fraise

Attachement

Arbre porte-fraise D10

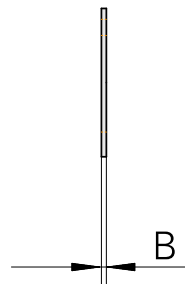
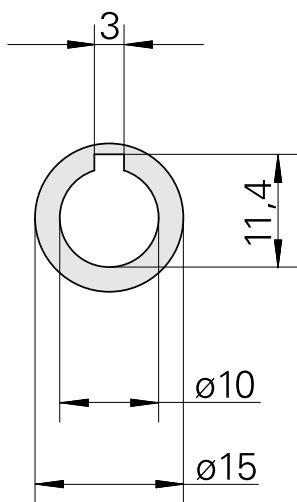

## **Documents**

Aucun téléchargement n'est disponible pour ce produit