

## Douille de guidag T223 Ø=17,00

### Données techniques

Taille des organes de bridage	T223
Fabr. tiers gamme prod.	
Modèle d'organe de bridage	Avec insert HM
Diamètre nominal (mm)	17 Millimeter
Méthode de serrage	Serrage extérieur
Modèle de pince de bridage	réglable
Variante de pince de bridage	Fentes vulcanisées (standard)
Fabr. tiers gamme prod.	Schlenker

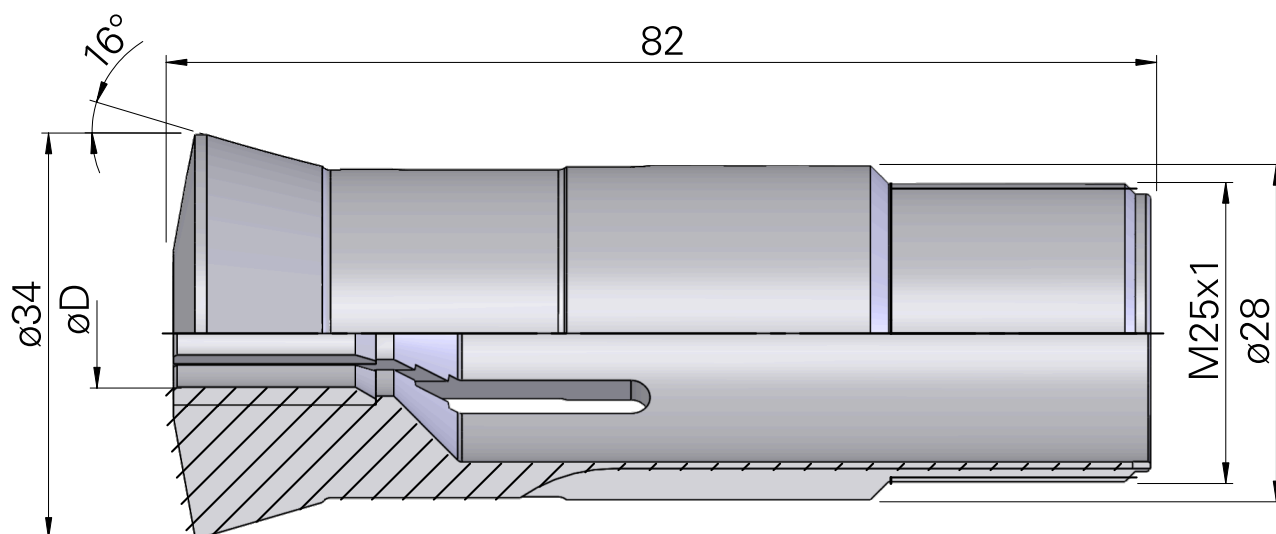

## **Documents**

Aucun téléchargement n'est disponible pour ce produit