

Saw blade, circular saw blade width 2 mm (0.07")

Technical features

TH accessories category

Circular saw blade d50

Tool mounting

13 mm

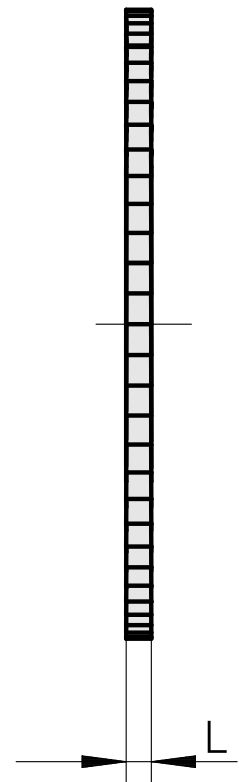
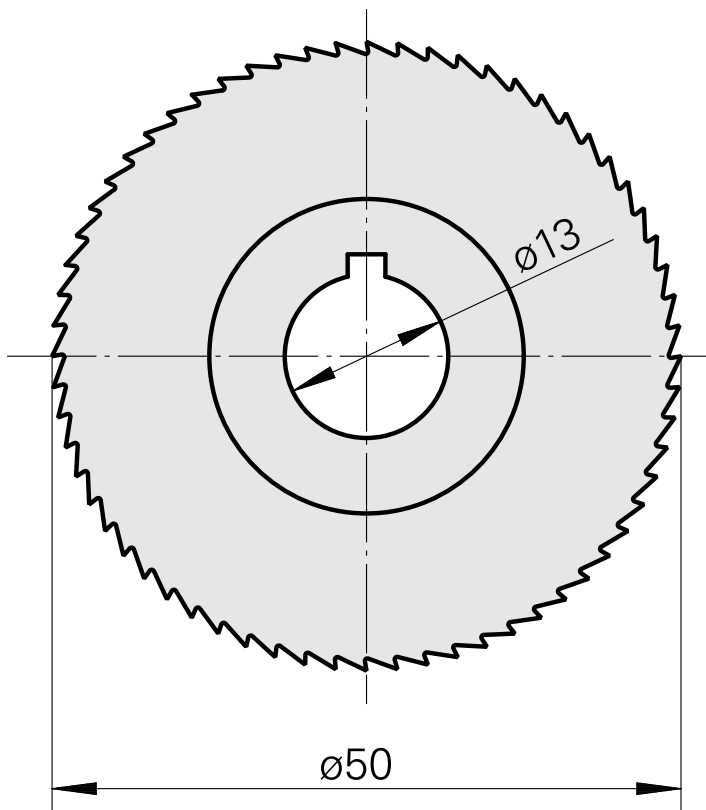
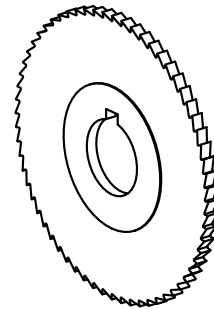

Documents

No downloads available for this product