

## WFB 32-20 Mandrin de frettage D4

### Données techniques

Catégorie d'accessoires PO

WFB 32-20

Attachement

Mandrin de frettage D4

Inserts à changement rapide

attachement fretté

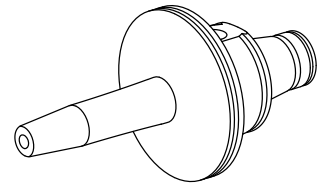

## **Documents**

Aucun téléchargement n'est disponible pour ce produit