

## WFB 32-20 Schrumpfaufnahme D3

### Technische Daten

**WZH Zubehörkategorie**

WFB 32-20

**Aufnahme**

Schrumpfaufnahme D3

**Schnellwechseleinsätze**

Schrumpfaufnahme

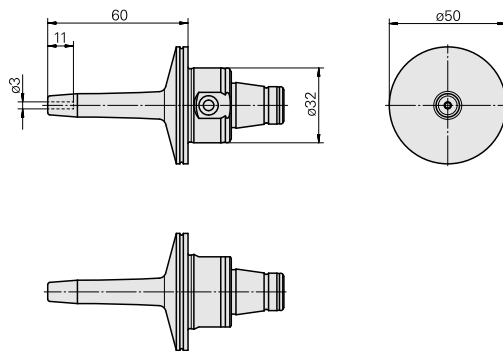
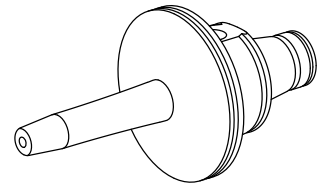

## **Dokumente**

Für dieses Produkt sind keine Downloads vorhanden