

## WFB 32-20 D8

### Technical data

TH accessories category	WFB 32-20
Mounting	D8
Quick change inserts	Weldon mounting

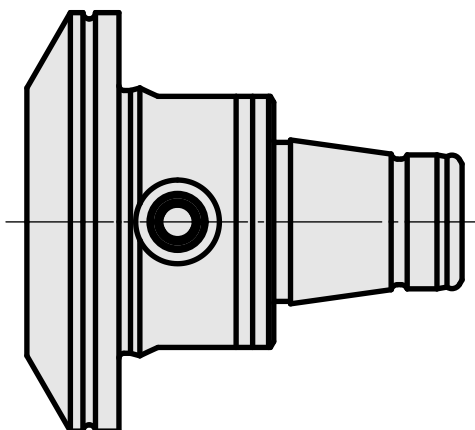
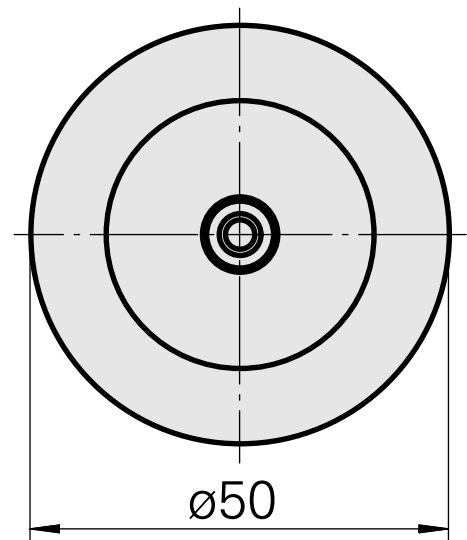
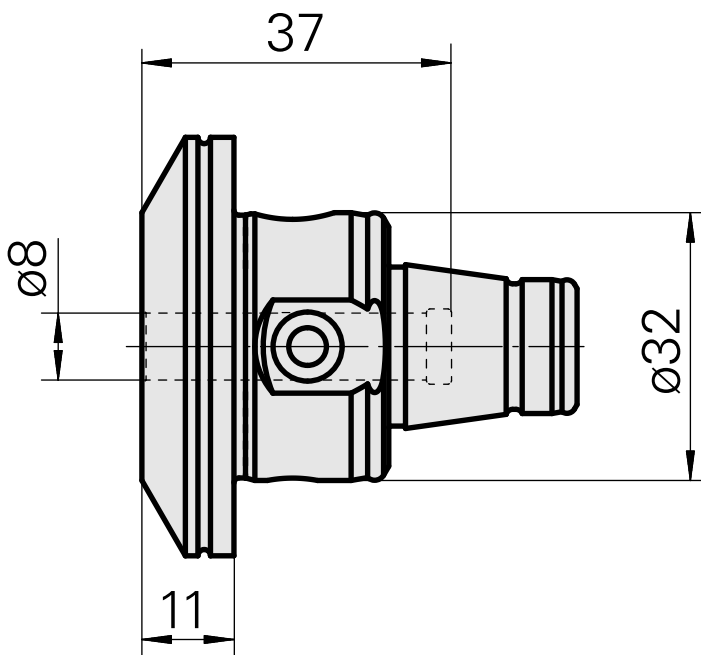
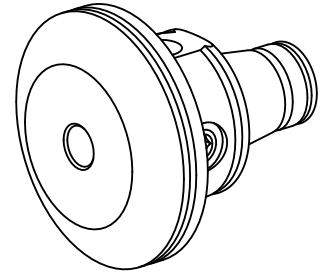

## **Documents**

No downloads available for this product