

Adaptor

Technical data

TH accessories category

Adapter for presetting units

Mounting

SK50

Tool mounting

Drill holding block D24mm

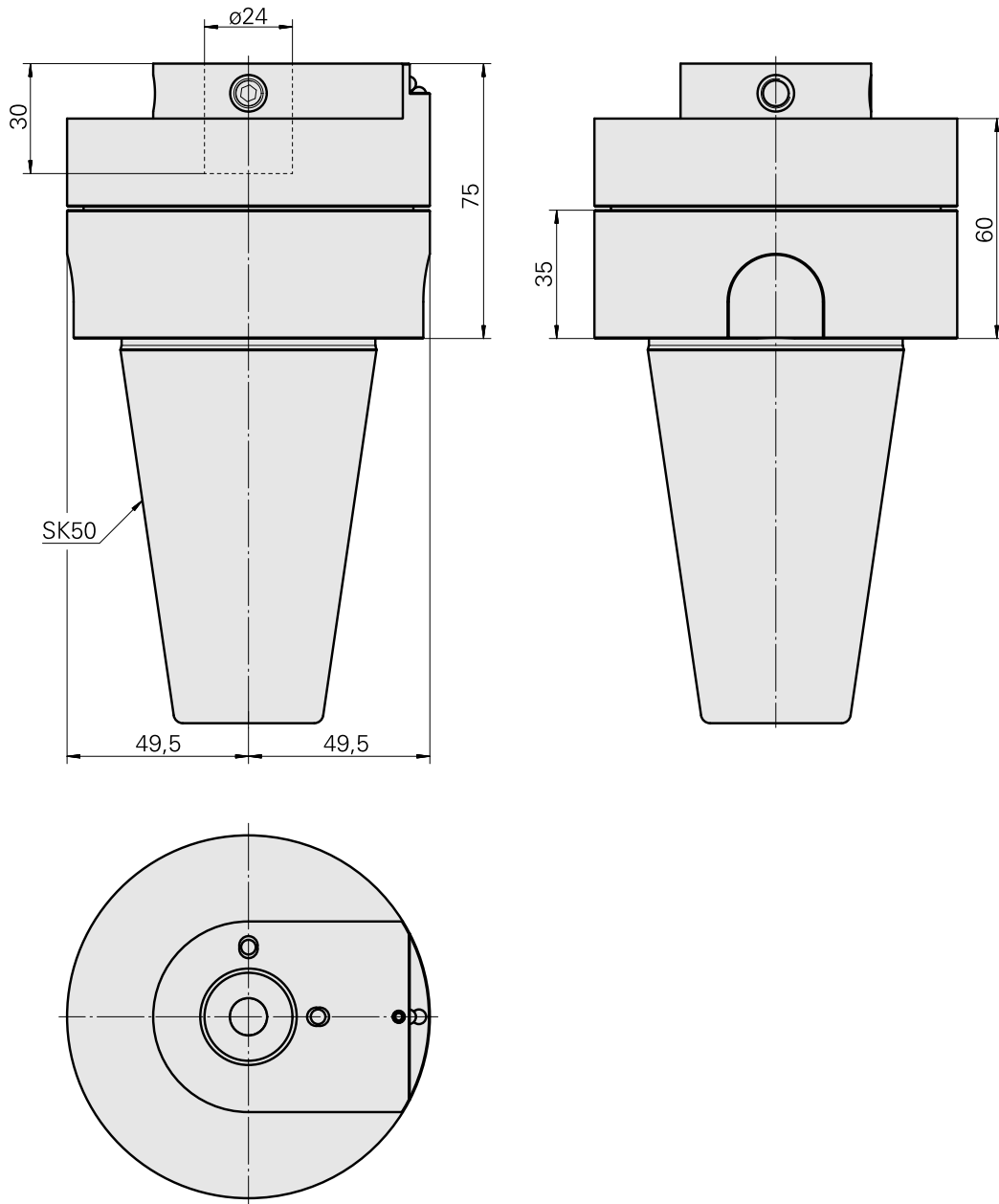
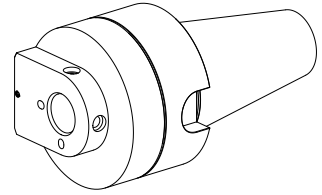

Documents

No downloads available for this product