

Adaptor

Características técnicas

PF Categoria de acessórios

Adaptador para apar.pré-ajuste

Recepção

SK50

Alojamento de ferramenta

WFB 24-16

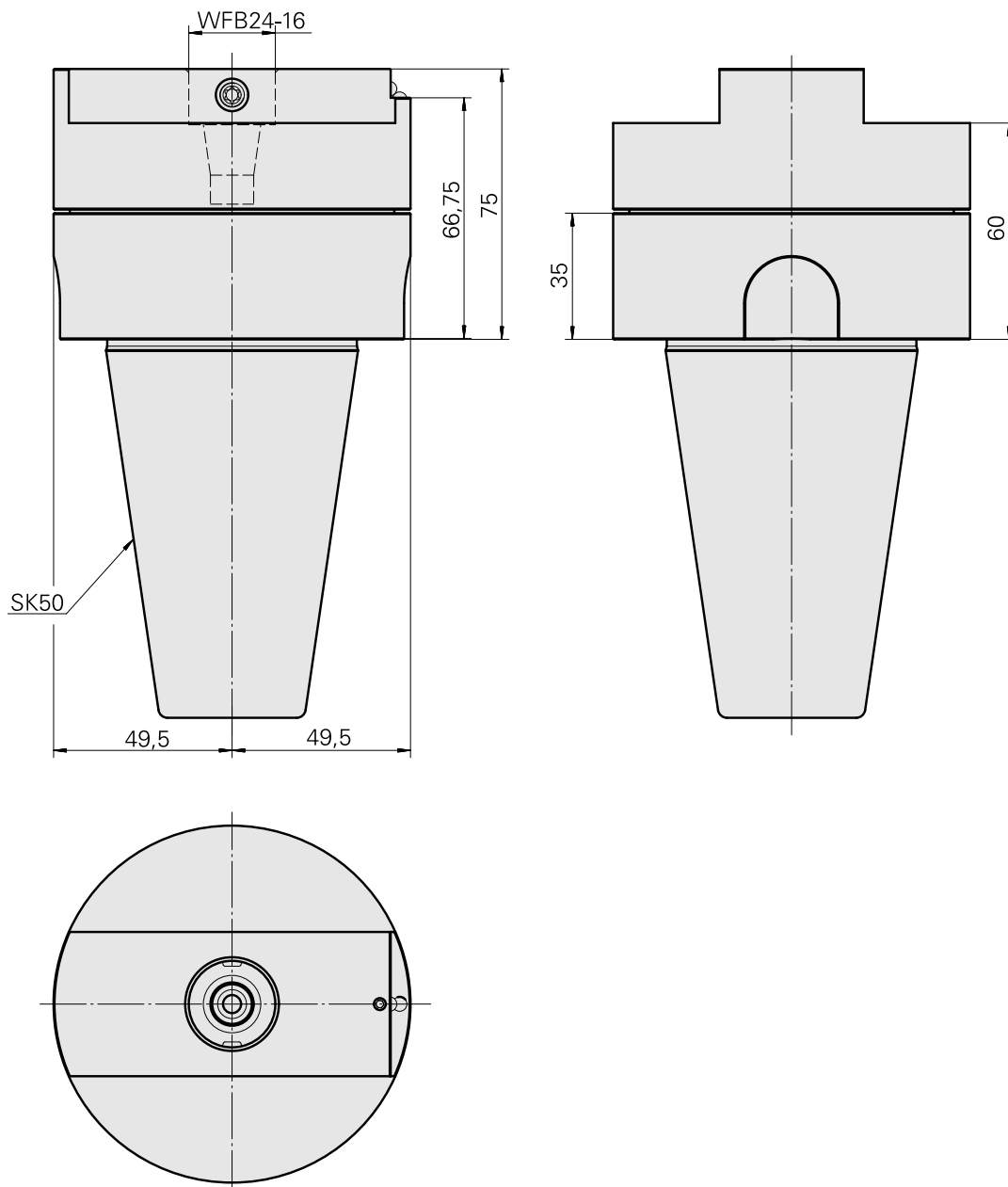
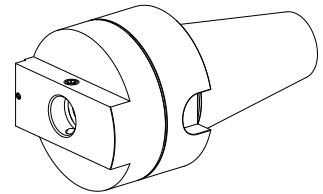

Documentos

Não há downloads disponíveis para este produto