

## ER-Collet chuck for taps ET 1-25 4.5mm

### Technical data

TH accessories category	ER-Collet chuck for taps
Mounting	ER25
Tool mounting	4.5mm
Collet type	ET 1-25

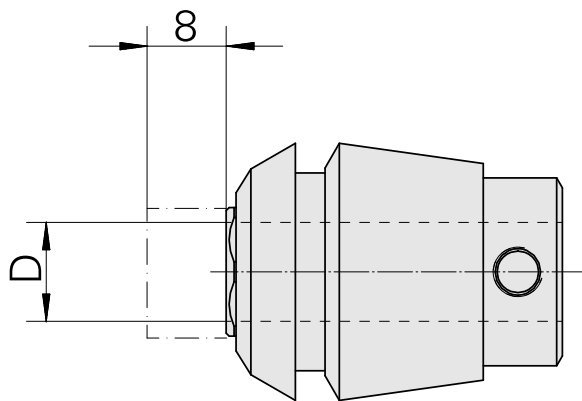

11052907  
322460

**INDEX**

---

## **Documents**

No downloads available for this product