

Milling unit Circular prism 2:1 ER20

Technical data

Shank TNL	Circular prism
Drive	Overall drive
Fixation TNL	Central tensioning screw
Speed ratio	2:1
Cooling	external
Pressure	30 bar
Mounting	ER20
INDEX TRAUB products	TNK36 • TNL26

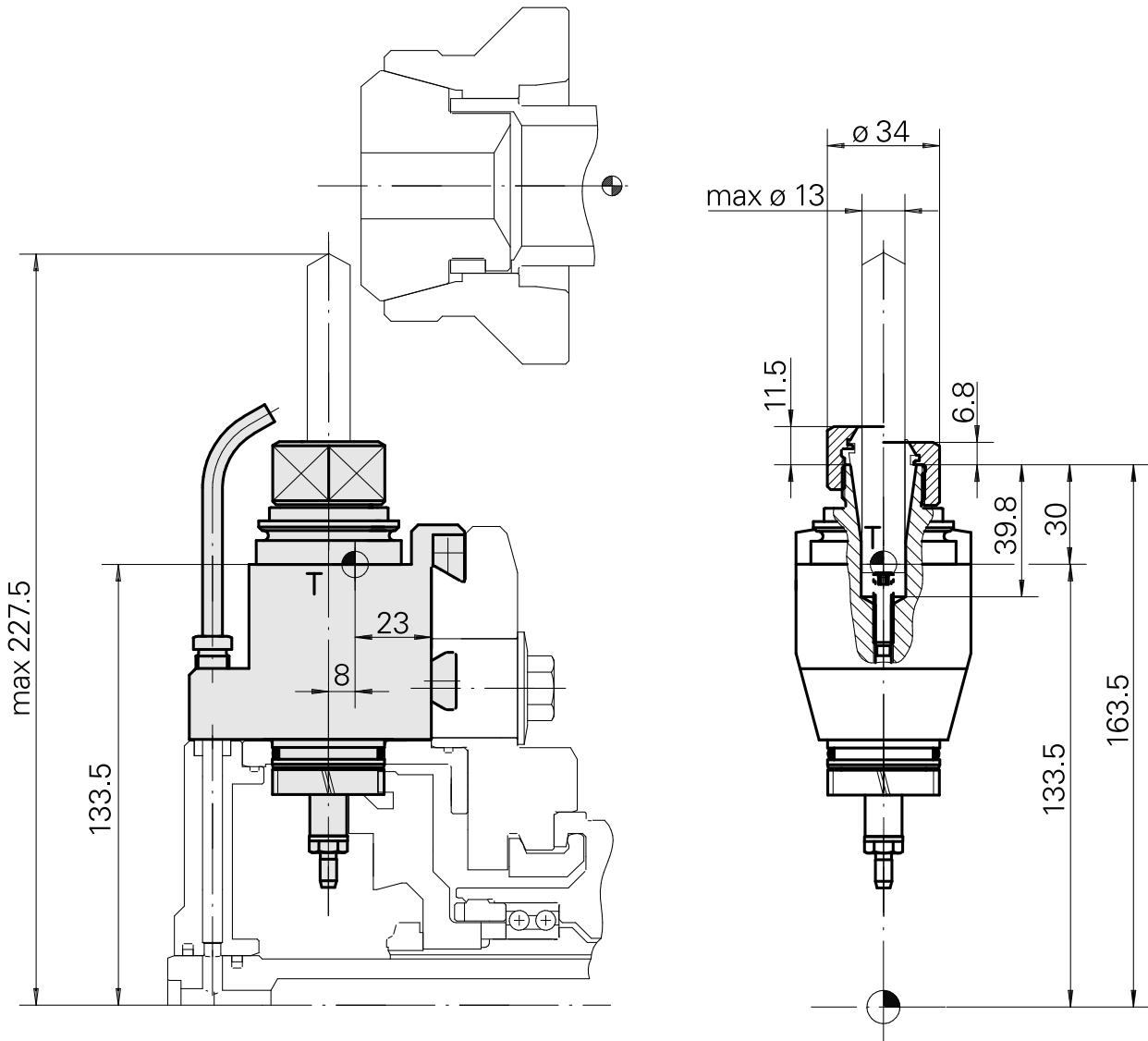
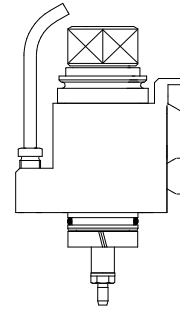

Documents

No downloads available for this product

Accessories

Required for operation

[Spanner](#)

Product ID : 10603529

Previous product ID : 490219.0201

TH accessories category Tool	Mounting ER20	Collet type ER 20	Clamping nut type Female thread
Tools for Collet chucks Clamping nut wrench			

Optional accessories

Tool holder accessories

[Clamping nut](#)

Product ID : 10137535

Previous product ID : 901939.0201

TH accessories category Clamping nut	Mounting ER20	Collet type ER 20	Clamping nut type Female thread
---	------------------	----------------------	------------------------------------

Other accessories

[Clamping collet](#)

Product ID : 10863981

Previous product ID : 901930.2---

[tapping tool collet ET-1-20](#)

Product ID : 10418139

Previous product ID : 3234--

11022179
836909

INDEX

[Collet chuck](#)

Product ID : 10135002

Previous product ID : W999066-
