

Clamping head SK65 D=5,5mm

Technical data

Clamping device size	SK65
manufacturer product line	SPANNTOP nova chuck
Clamping type	smooth
Nominal diameter (mm)	5.5 Millimeter
Clamping method	External clamping
manufacturer product line	Hainbuch

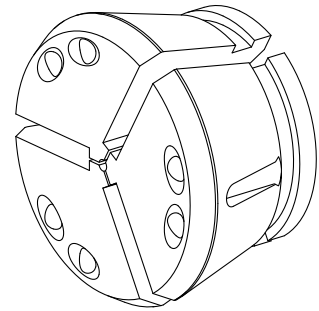

No 3-side view is currently available for this product

Documents

No downloads available for this product