

WFB 32-20 Milling shaft D16

Technical data

TH accessories category

WFB 32-20

Mounting

Milling shaft D16

Quick change inserts

mill arbor mounting

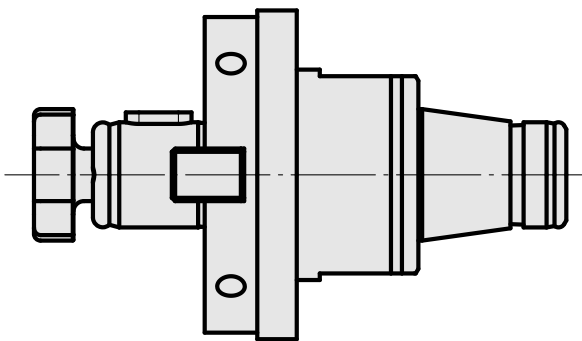
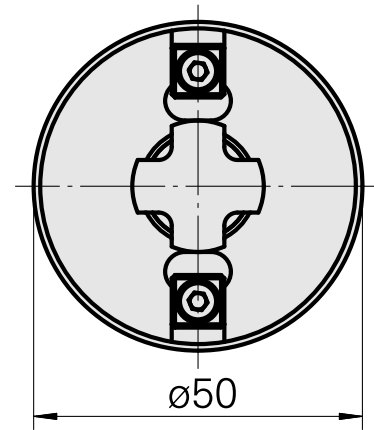
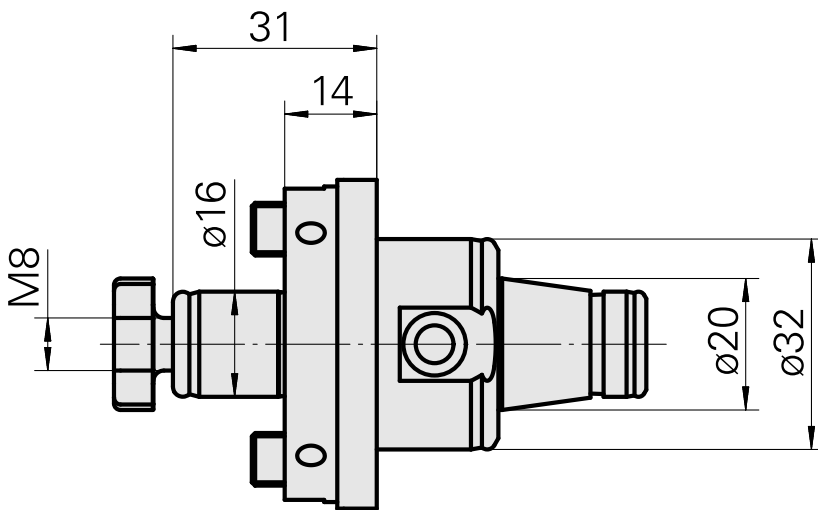
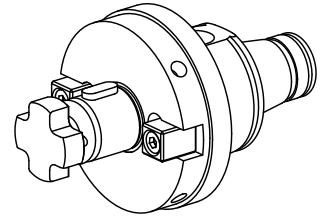

Documents

No downloads available for this product

Accessories

Required for operation

[mill arbor wrench](#)

Product ID : 10007866

Previous product ID : 203020.1160

TH accessories
category
Tool

Mounting
Milling shaft D16

Tools for Collet chucks
Mill arbor wrench

Optional accessories

Tool holder accessories

[Screw](#)

Product ID : 10381768

Previous product ID : 250122.0820

TH accessories
category
Cutter tightening screw

Mounting
M8

Other accessories

[Ring](#)

Product ID : 10398855

Previous product ID : 251390.----

[Ring](#)

Product ID : 10169490

Previous product ID : 251391.----
