

WFB 32-20 D8

Technical data

TH accessories category	WFB 32-20
Mounting	D8
Quick change inserts	Weldon mounting

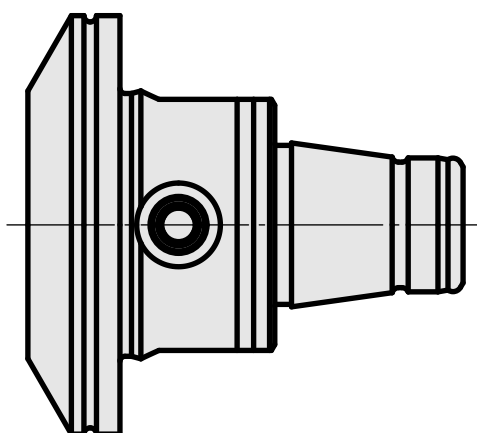
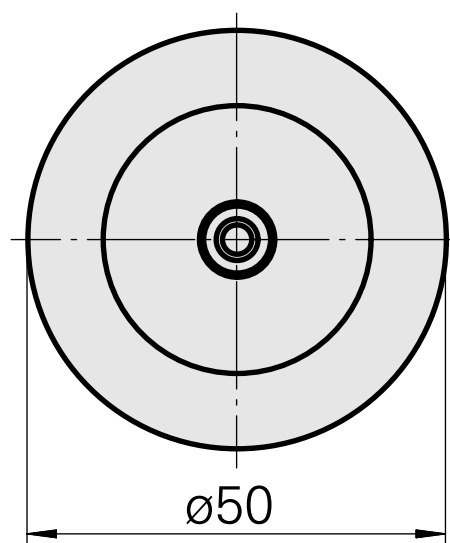
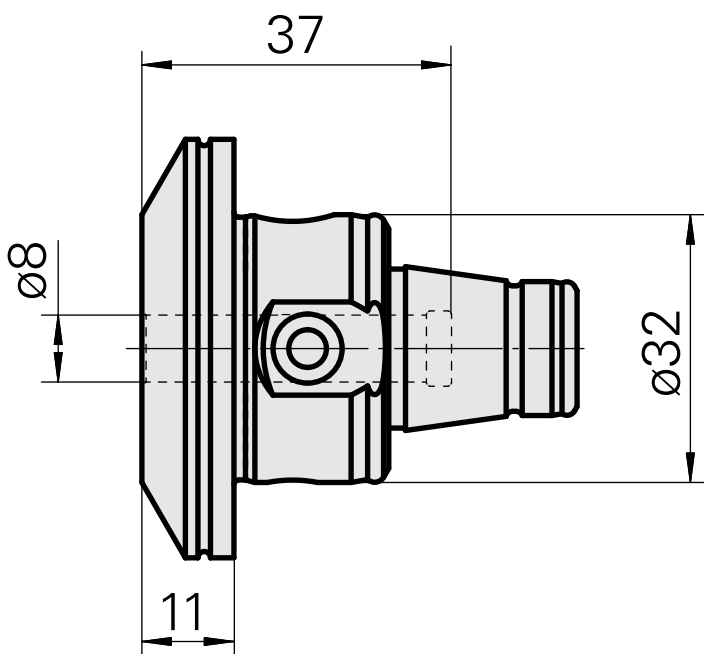
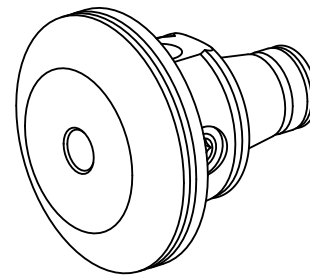

10746330
W9991066

INDEX

Documents

No downloads available for this product