

Mount

Technical features

TH accessories category

Adapter pre-adjustment block

Tool mounting

HSK 40

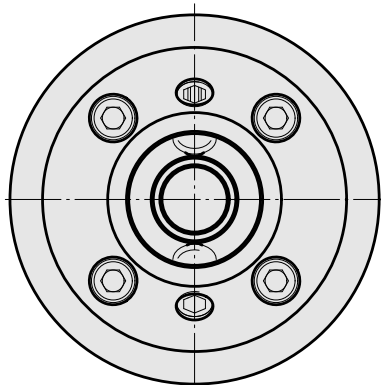
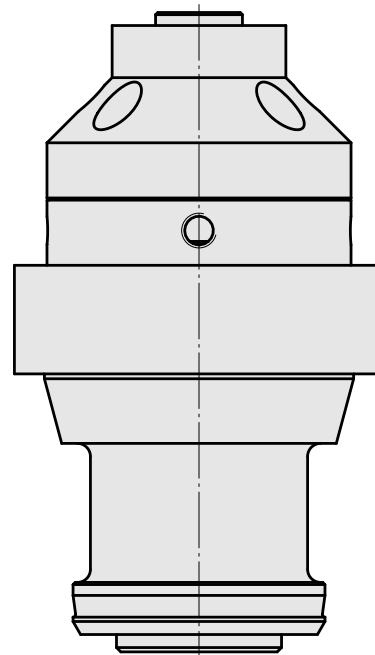
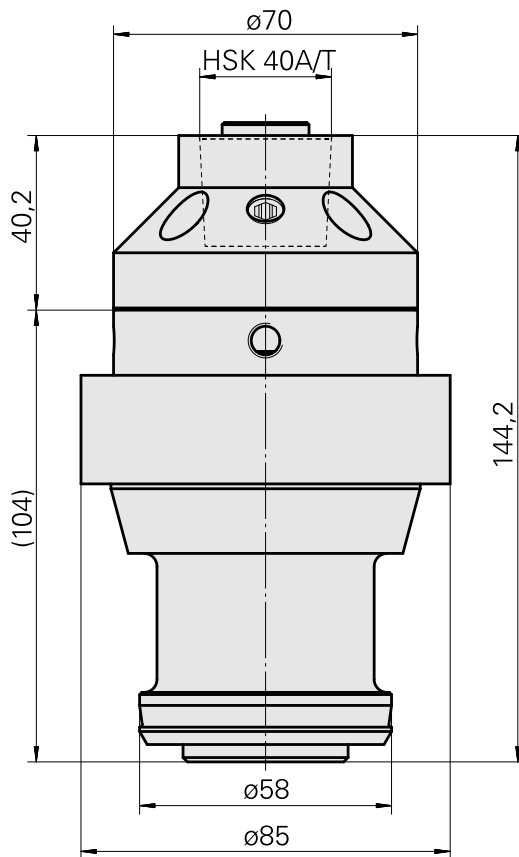
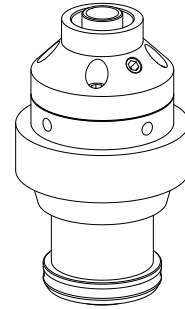

Documents

No downloads available for this product