

WFB 32-20 Shrink-fit mounting D6

Technical data

TH accessories category

WFB 32-20

Mounting

Shrink-fit mounting D6

Quick change inserts

shrink-fit mounting

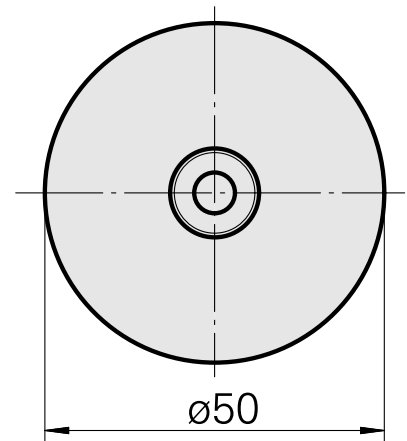

10650474
836262

INDEX

Documents

No downloads available for this product