

## Saw blade, circular saw blade width 0.4 mm (0.015")

### Technical data

TH accessories category

Circular saw blade d63

Tool mounting

16mm

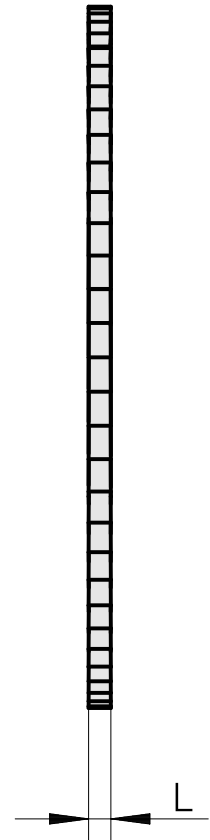

10342595  
223010.6304

**INDEX**

---

## **Documents**

No downloads available for this product