

Guide bush T229 Ø=18,00

Technical data

| | |
|---|-----------------------------|
| Clamping device size manufacturer product line | T229 deadlength |
| Clamping type | with carbide insert |
| Nominal diameter (mm) | 18 Millimeter |
| Clamping method | External clamping |
| Collet design | programmable (Axfix) |
| Collet version | Slots vulcanized (standard) |
| manufacturer product line | Schlenker |



Note

with bushing

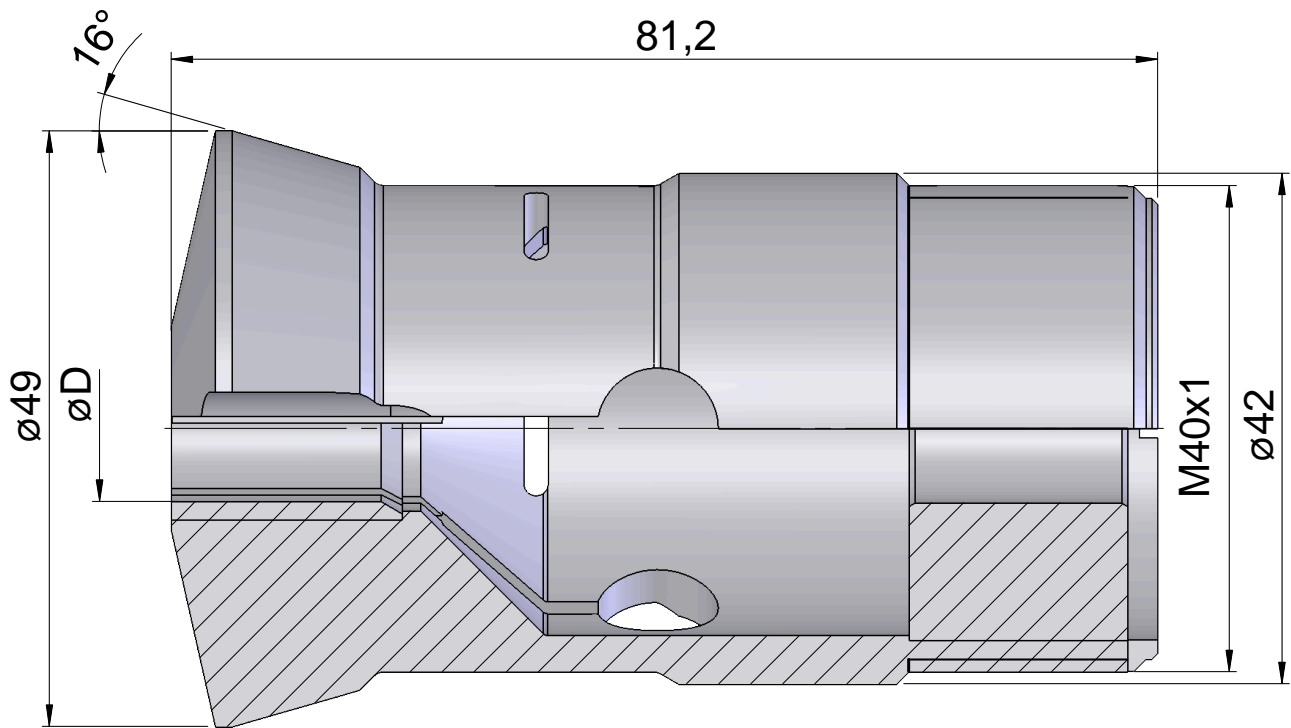

Documents

No downloads available for this product