

Drilling tool holder Shank 40 ER16

Características técnicas

Shank TNL	Shank 40
Drive	not live
Cooling	internal
Pressure	120 bar
Mounting	ER16
INDEX TRAUB products	TNK36 • TNL26

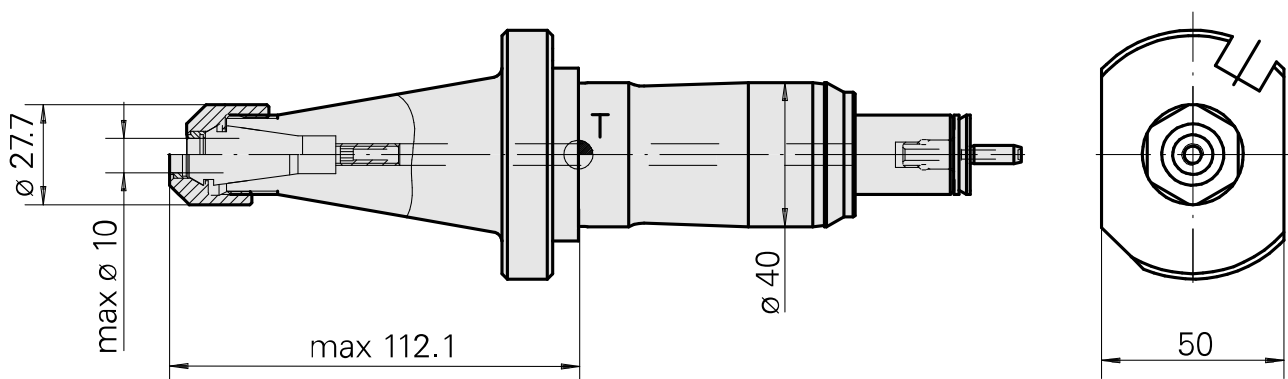
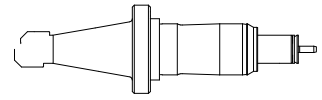

Documentos

Não há downloads disponíveis para este produto

Acessórios

Necessário para operação

[Spanner](#)

ID do produto : 10966369

ID anterior do produto : 490219.0161

TH accessories category Tool	Mounting ER16	Collet type ER 16	Clamping nut type Female thread
Tools for Collet chucks Clamping nut wrench			

Acessórios opcionais

Tool holder accessories

[Porca tensora, para alimentação de fluido de corte interna](#)

ID do produto : 11065621

ID anterior do produto : 901939.3161

PF Categoria de acessórios Garra	Recepção ER16	Tipo de pinça de aperto ER 16	Fixação do tipo porca Rosca
-------------------------------------	------------------	----------------------------------	--------------------------------

Outros acessórios

[Clamping collet](#)

ID do produto : 10589709

ID anterior do produto : W99903--

[Clamping collet](#)

ID do produto : 10834596

ID anterior do produto : 901930.1---

[tapping tool collet](#)

ID do produto : 10865233
ID anterior do produto : WZ9990.9506F

[tapping tool collet ET-1-16](#)

ID do produto : 10542491
ID anterior do produto : 3230--

[Porta pinça](#)

ID do produto : 10870393
ID anterior do produto : W999065-

[Pinça de aperto, selado](#)

ID do produto : 10433061
ID anterior do produto : W999083-

[Vedação](#)

ID do produto : 10324863
ID anterior do produto : W999036-
