

Clamping nut

Technical data

TH accessories category

Clamping nut

Mounting

ER20

Collet type

ER 20

Clamping nut type

Female thread

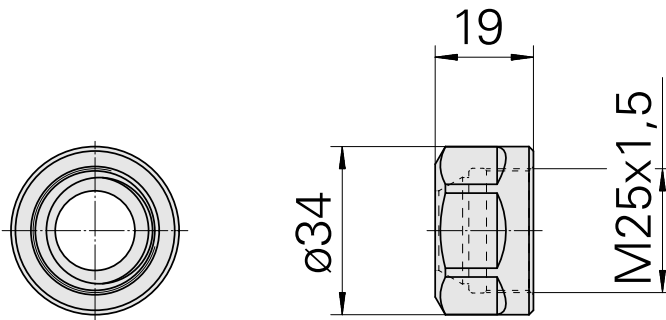
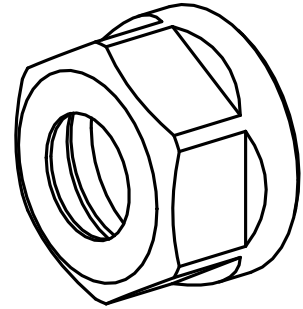

Documents

No downloads available for this product