

Presetting device D80/MS32/MS40 Quersch

Technical data

TH accessories category

Adapter for presetting units

Mounting

D80 for presetting devices

Tool mounting

MS32/MS40 Cross slide

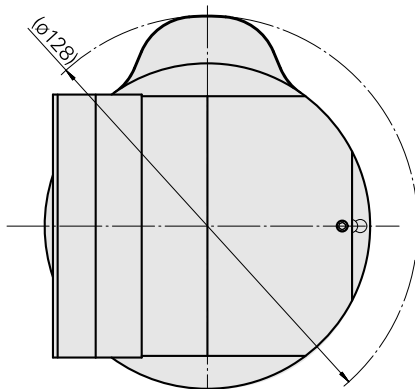
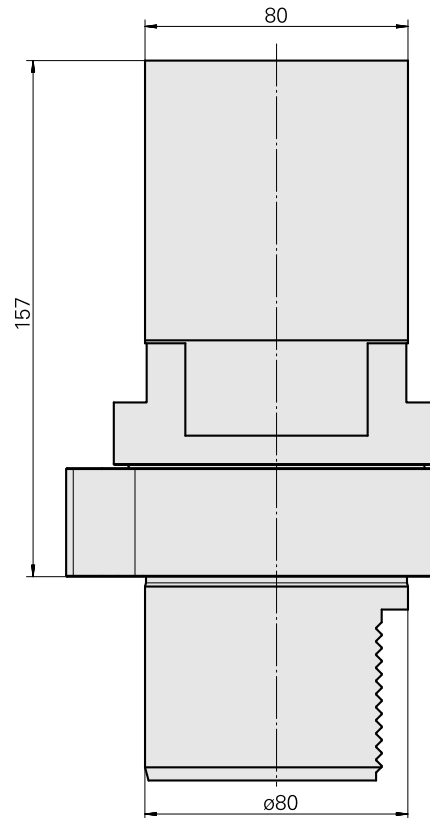
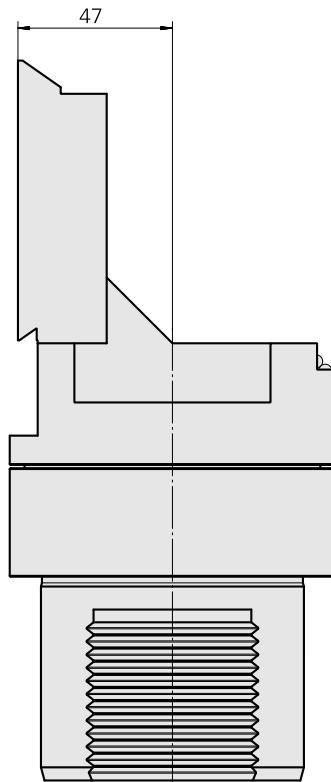
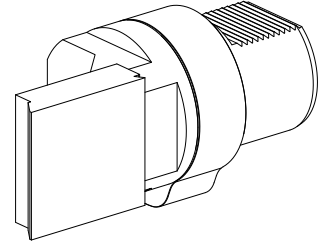

Documents

No downloads available for this product