

WFB 20-12 D14

技术特点

刀座附件类别
夹具
快换夹头

WFB 20-12
D14
用于镗刀架

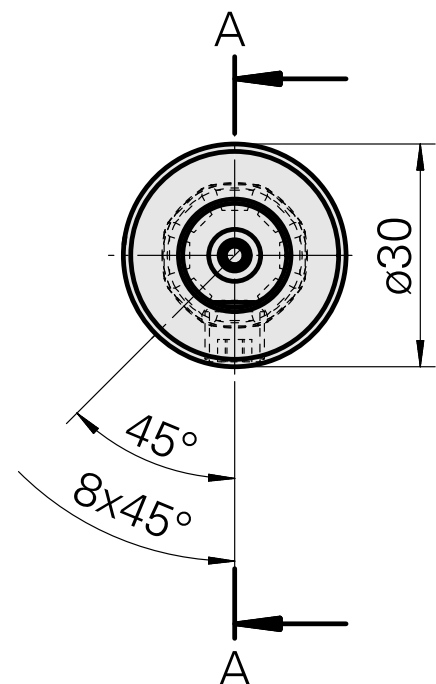
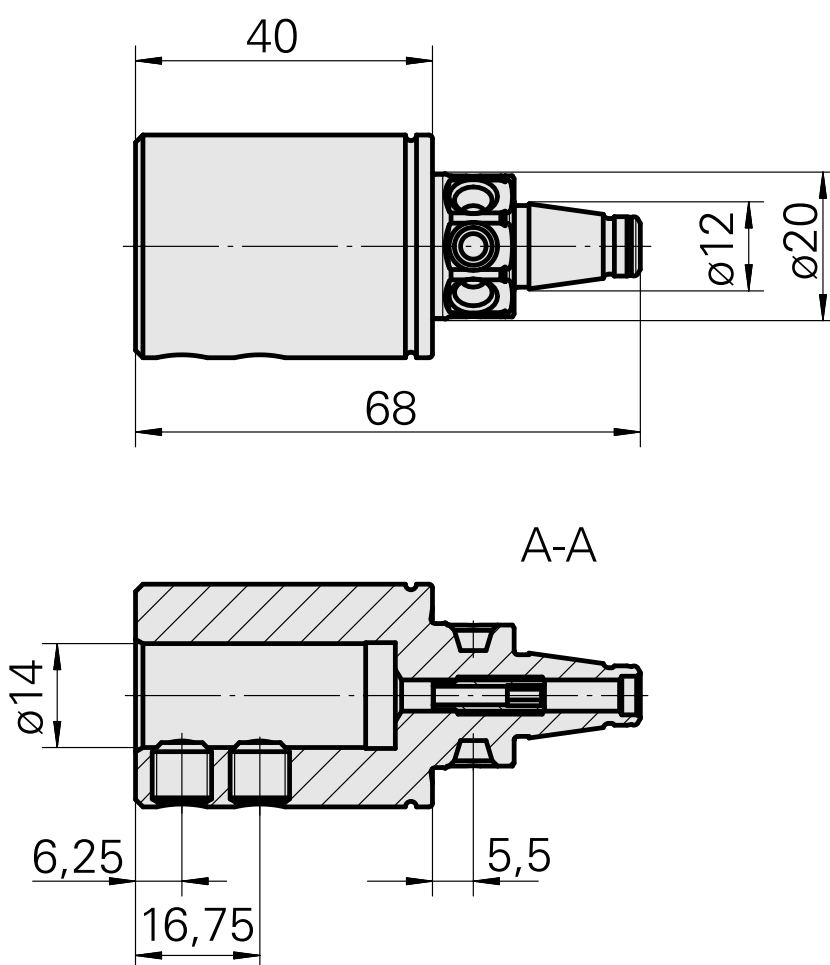
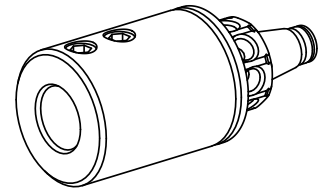

文件

没有针对此产品的任何下载

附件

可选附件

其他附件

[带肩安装套 D20](#)

产品ID：10063939

以前的产品ID：W68510.04--

[Adjusting screw M 5x15](#)

产品ID：10491071

以前的产品ID：326794

[Grub screw](#)

产品ID：10921433

以前的产品ID：410156.0808
