

Guide bush T229 Ø=19,00

Technical data

Clamping device size	T229
manufacturer product line	
Clamping type	with carbide insert
Nominal diameter (mm)	19 Millimeter
Clamping method	External clamping
Collet design	adjustable
Collet version	S-slot
manufacturer product line	Schlenker

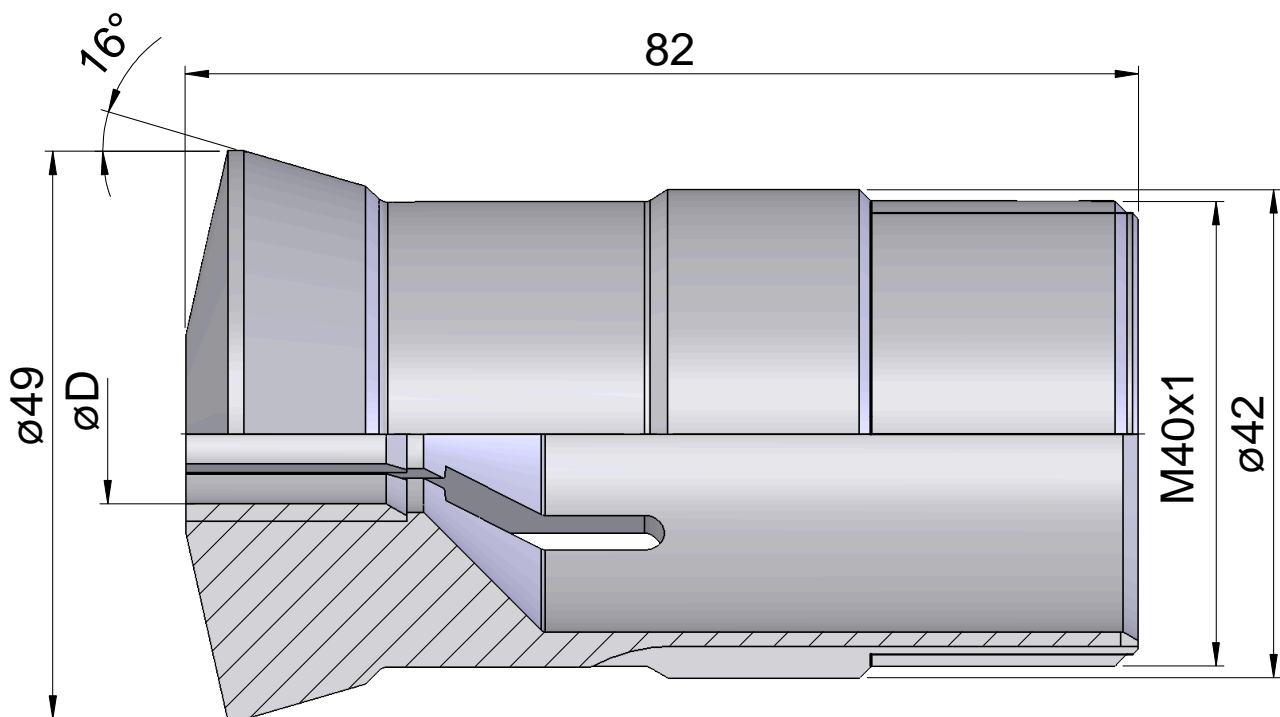
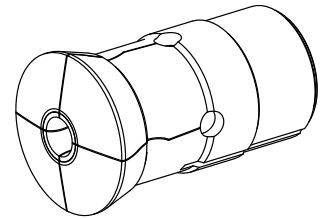

Documents

No downloads available for this product