

Guide bush T223 Ø=6,00

Technical data

Clamping device size manufacturer product line	T223 deadlength
Clamping type	with carbide insert
Nominal diameter (mm)	6 Millimeter
Clamping method	External clamping
Collet design	programmable (Axfix)
Collet version	S-slot
manufacturer product line	Schlenker

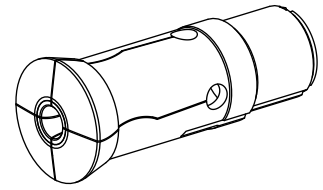

Note

with bushing

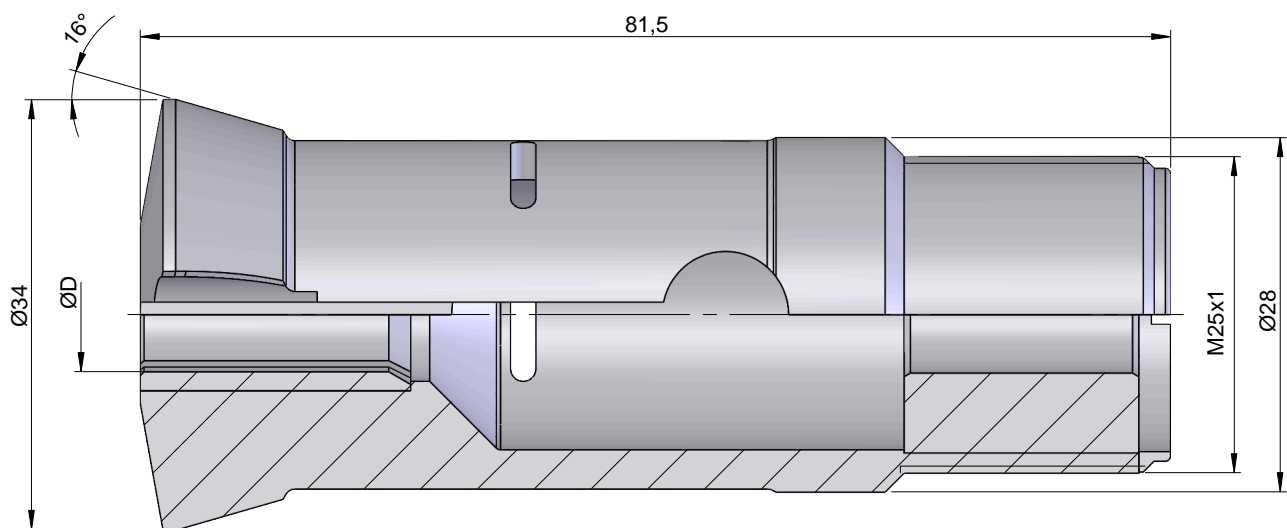

Documents

No downloads available for this product