

## Guide bush T229 Ø=17,00

### Technical data

Clamping device size manufacturer product line	T229 deadlength
Clamping type	with carbide insert
Nominal diameter (mm)	17 Millimeter
Clamping method	External clamping
Collet design	programmable (Axfix)
Collet version	S-slot
manufacturer product line	Schlenker

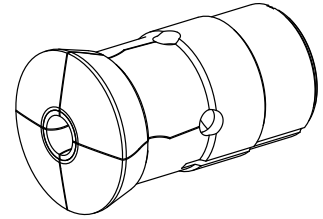

### Note

with bushing

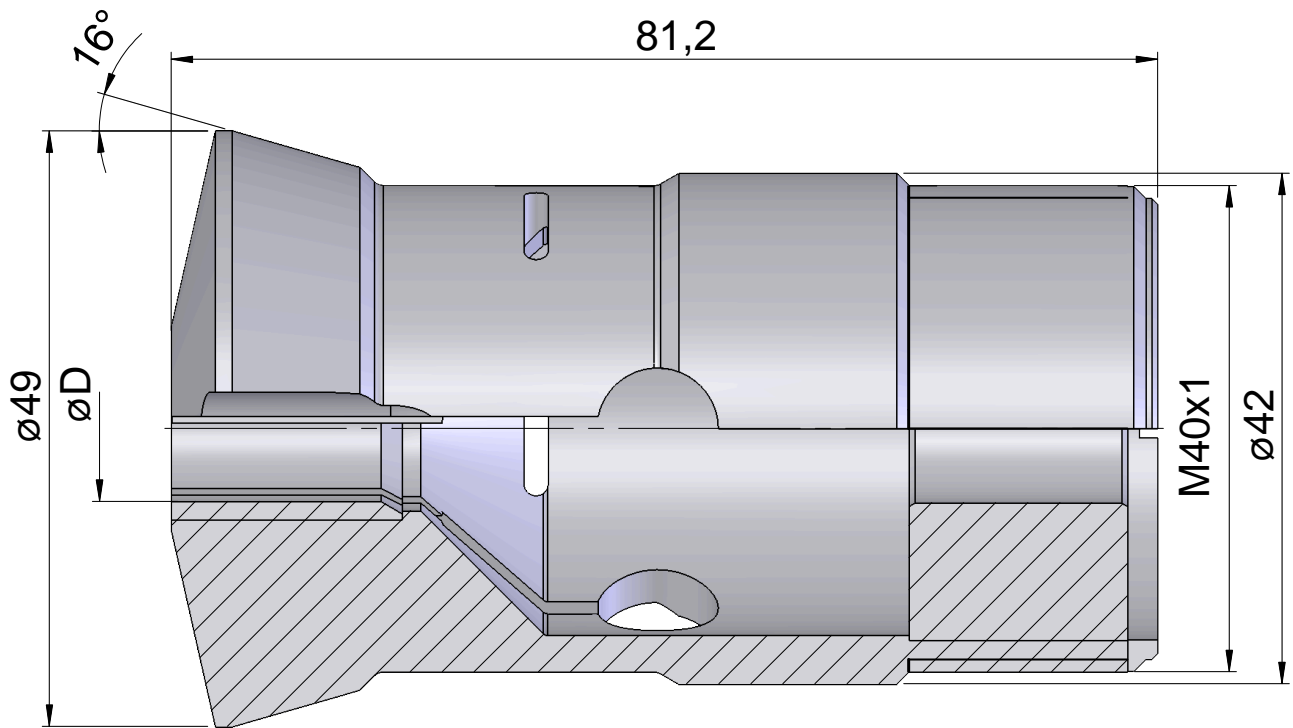

## **Documents**

No downloads available for this product