

WFB 20-12 Hydraulic expansion chuck D10

Technical data

TH accessories category

WFB 20-12

Mounting

Hydraulic expansion chuck D10

Quick change inserts

hydraulic expan. mounting

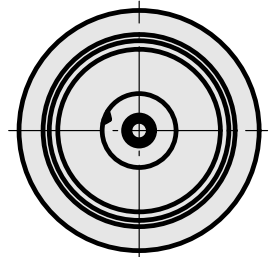
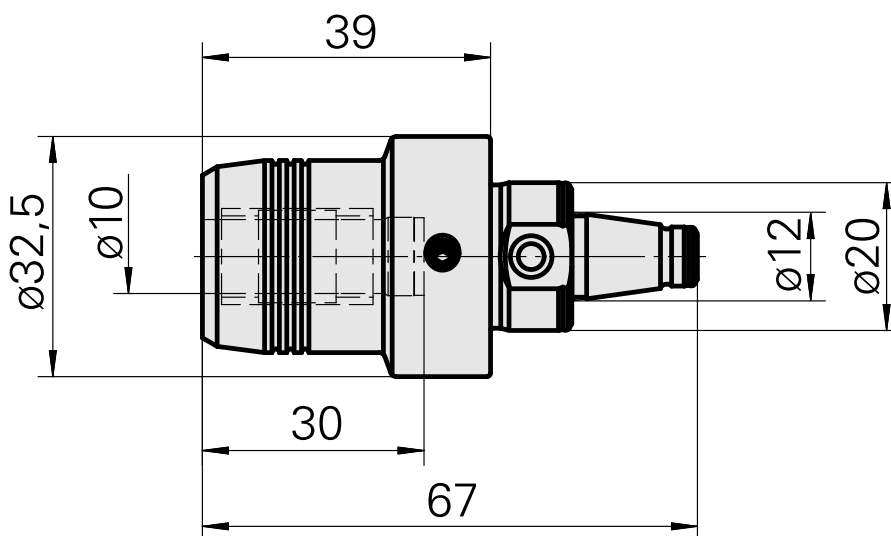
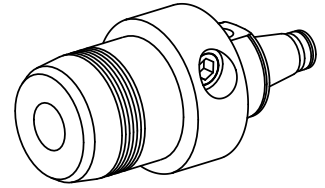

Documents

Product notes

[DE \(pdf\)](#)

[EN \(pdf\)](#)

[FR \(pdf\)](#)