

Boring head for DN.. 1506..

Technical data

Mounting	for DN.. 1506..
Cooling	internal
Pressure	50 bar
X [mm]	36 (1.42")
Z [mm]	35 (1.38)
INDEX TRAUB products	G220 • G420 • G520 • G320.2 • G220.3 • TNX220.3

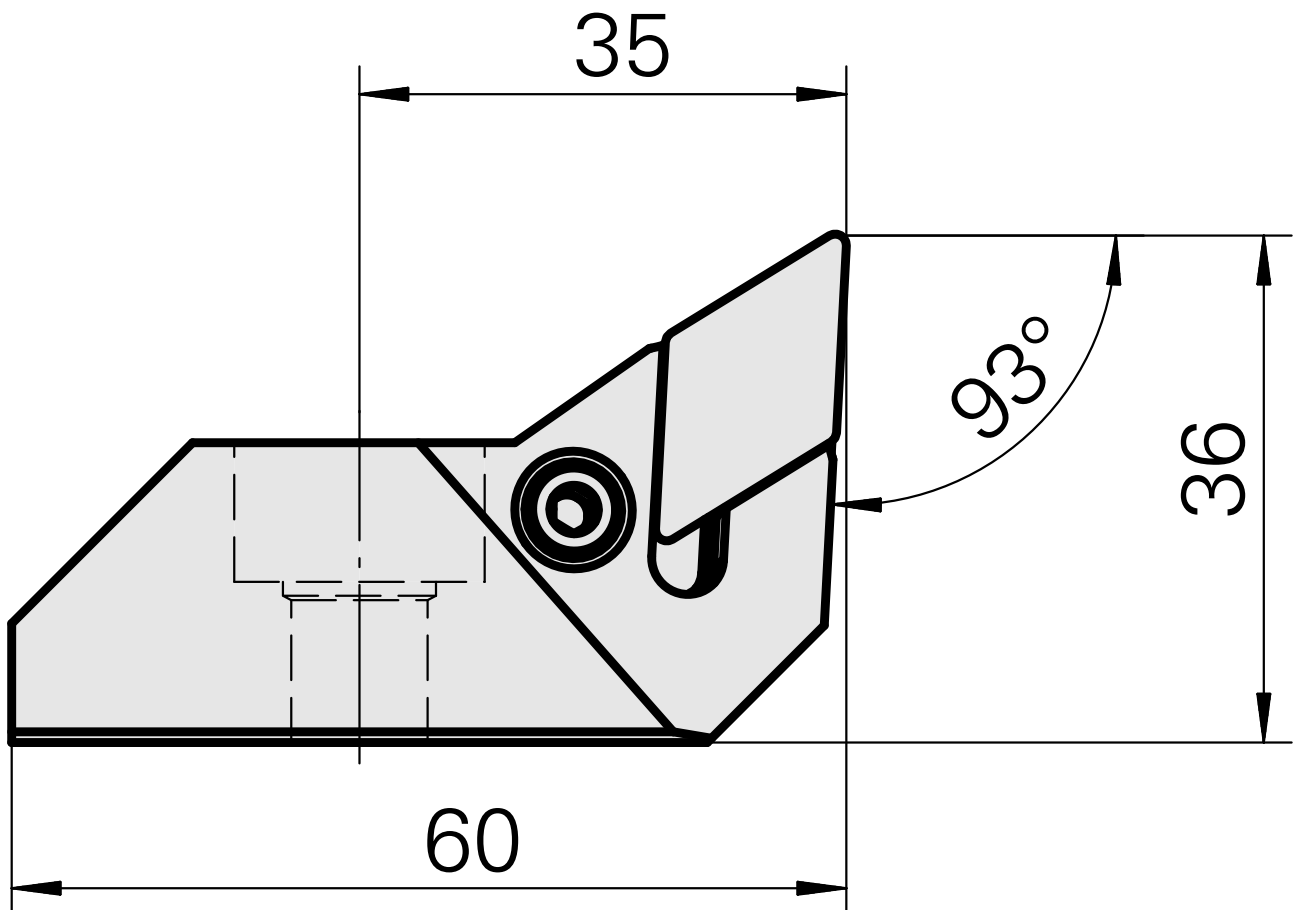
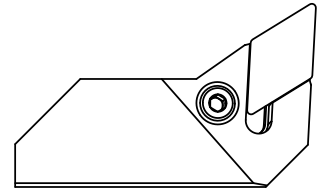

11171044
W9991321

INDEX

Documents

No downloads available for this product