

## Saw blade, circular saw blade width 0.3 mm (0.011")

### Technical data

TH accessories category

Circular saw blade d50

Tool mounting

13mm

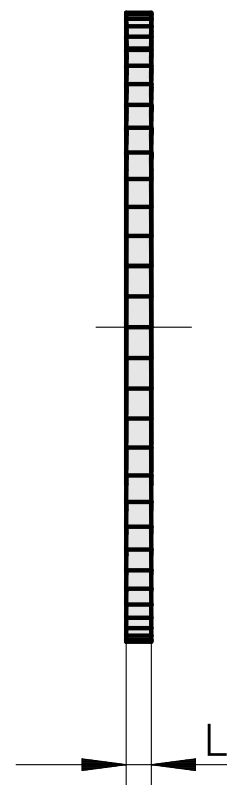
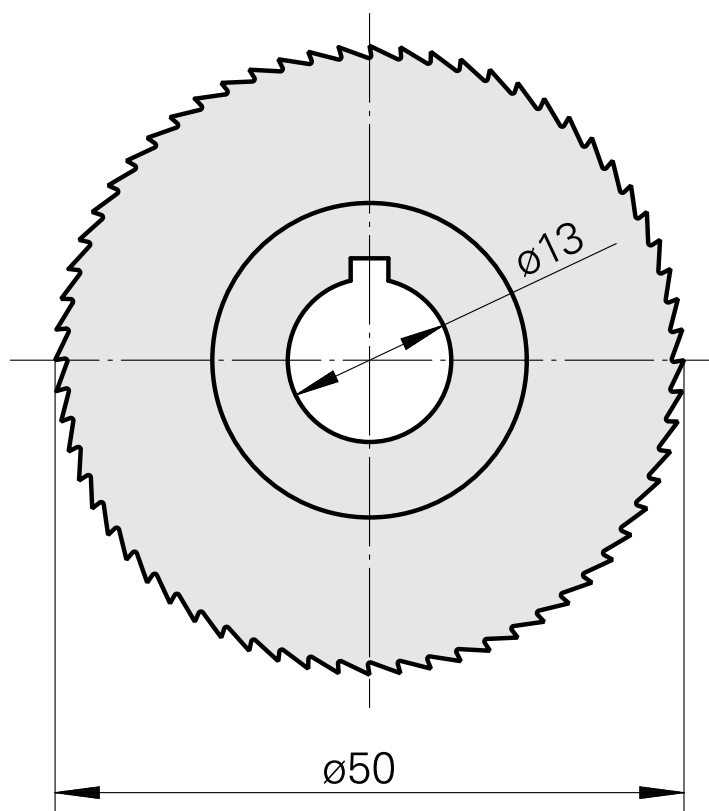
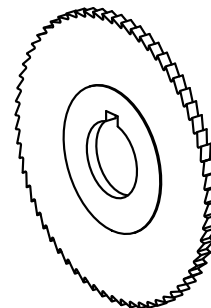

11053739  
223010.5003

**INDEX**

---

## **Documents**

No downloads available for this product