

ER-Collet chuck for taps ET 1-25 4.5mm

Technical data

TH accessories category	ER-Collet chuck for taps
Mounting	ER25
Tool mounting	4.5mm
Collet type	ET 1-25

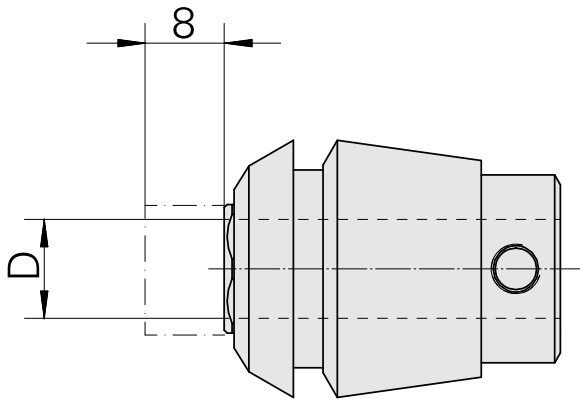

11052907
322460

INDEX

Documents

No downloads available for this product