

Drilling tool holder HSK 40 A DIN 1835 B

Technical data

Shank HSK	HSK 40
Form HSK	A
Mounting	DIN 1835 B/E D12
Cooling	internal
Pressure	80 bar
X [mm]	45.5 (1.79")
INDEX TRAUB products	G160 • V100 • G200.2 • R200 • TNX65/42 • G220.3 • TNX220.3

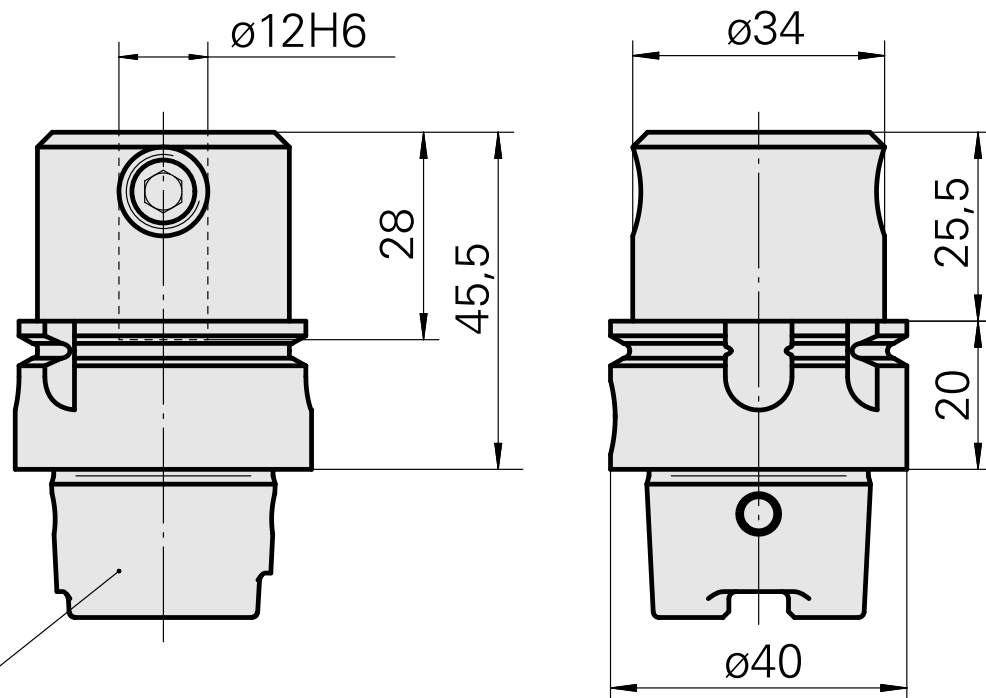

DIN 69893
HSK 40 A

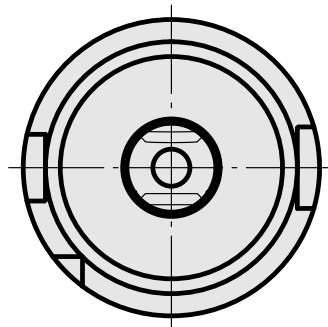

Documents

No downloads available for this product

Accessories

Required for operation

[Socket wrench](#)

Product ID : 10532354

Previous product ID : WS7400.0010

TH accessories
category
Tool for KSS adapter

Mounting
HSK 40 A/C

Optional accessories

Tool holder accessories

[Coolant adapter kit](#)

Product ID : 10581780

Previous product ID : WS7400.0020

TH accessories
category
Cooling lubricant
transfer set

Mounting
HSK 40 A/C

[Coolant supply, max. 120 bar](#)

Product ID : 12024083

Previous product ID :

TH accessories
category
Cooling lubricant
transfer set

Mounting
HSK 40 A/C