

Clamping head TOP65 D=6,00mm

Technical data

Clamping device size	SK65
manufacturer product line	TOPlus chuck
Clamping type	grooved
Nominal diameter (mm)	6 Millimeter
Clamping method	External clamping
manufacturer product line	Hainbuch

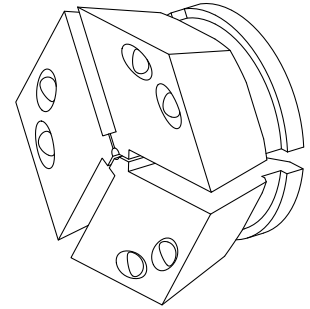

No 3-side view is currently available for this product

Documents

No downloads available for this product