

Clamping collet 138E/F20 Ø=9,00

Technical data

Clamping device size	138E/F20
manufacturer product line	
Clamping type	smooth
Nominal diameter (mm)	9 Millimeter
Clamping method	External clamping
Collet version	Slots vulcanized (standard)
manufacturer product line	Schlenker

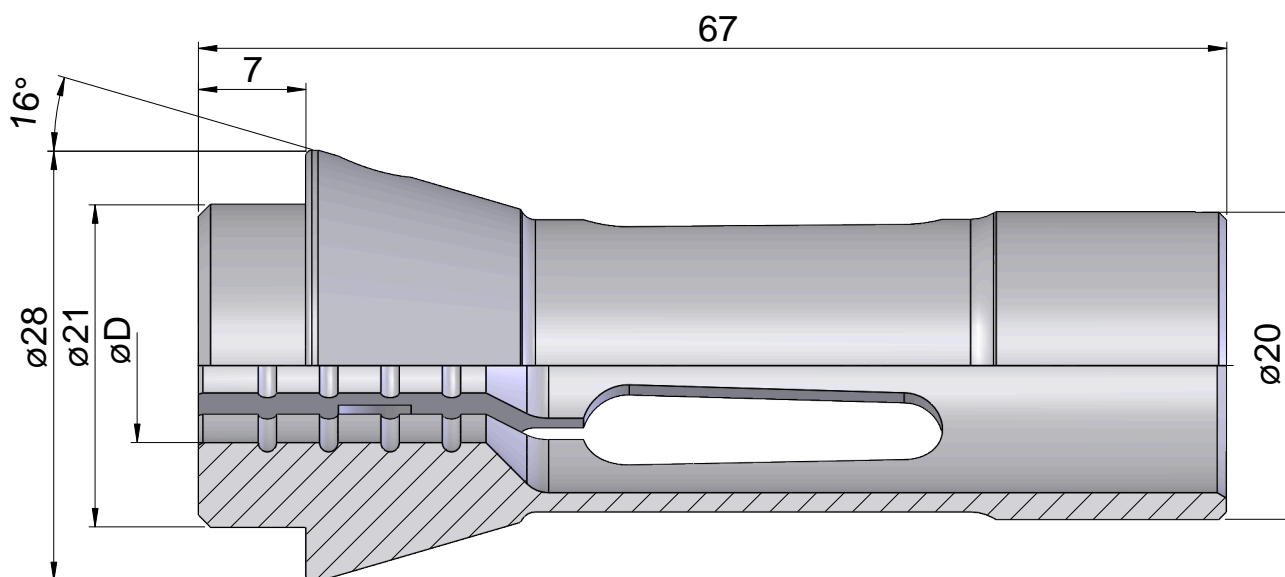
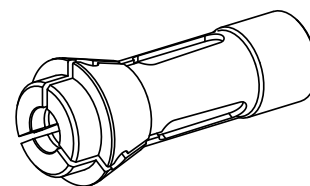

Documents

No downloads available for this product