

WFB 32-20 Shrink-fit mounting D10

Technical data

TH accessories category

WFB 32-20

Mounting

Shrink-fit mounting D10

Quick change inserts

shrink-fit mounting

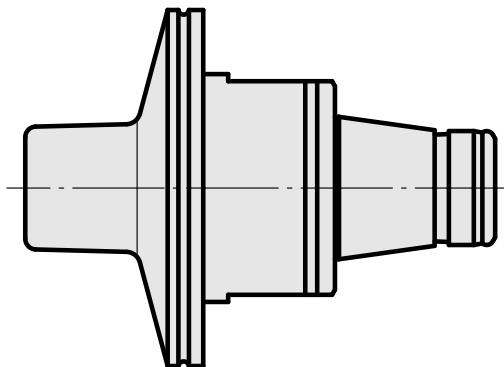
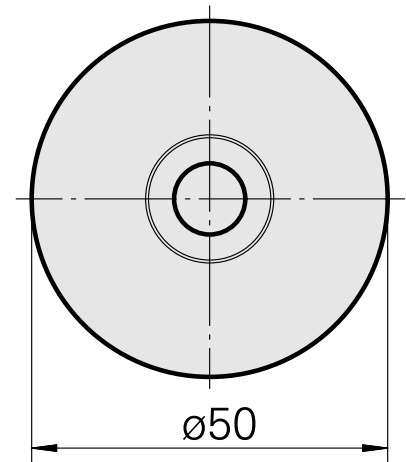
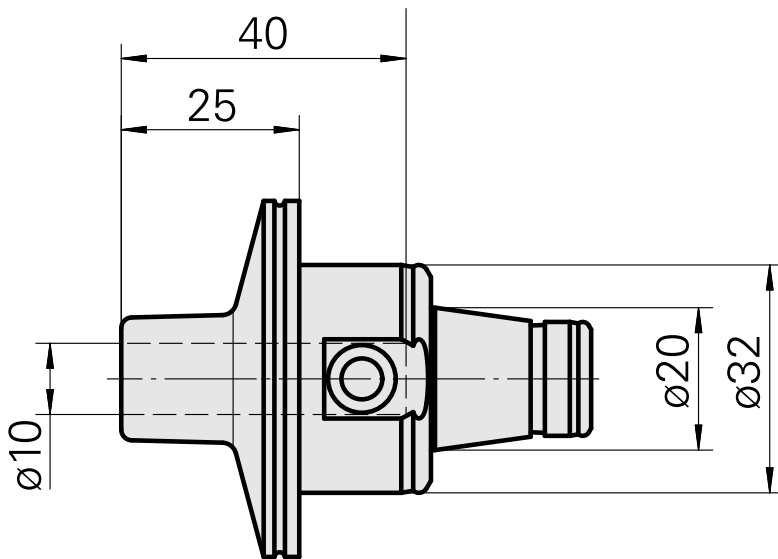
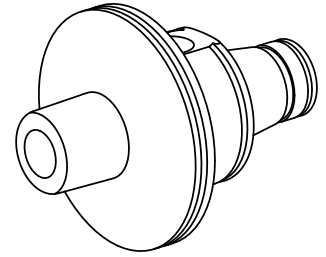

10803994
836264

INDEX

Documents

No downloads available for this product