

## Adaptor

### Technical data

TH accessories category

Adapter for presetting units

Mounting

SK50

Tool mounting

Drill holding block D22mm

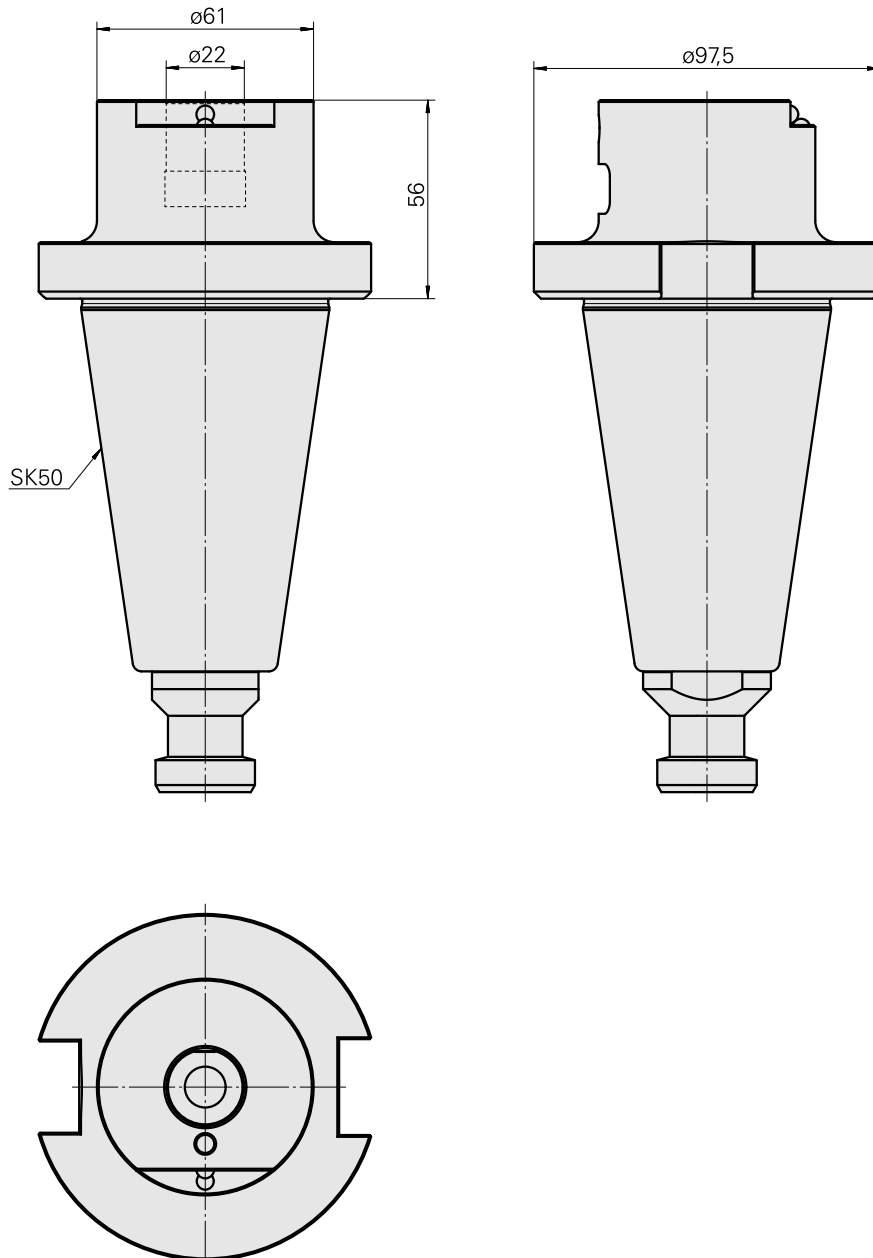
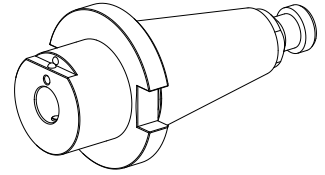

## **Documents**

No downloads available for this product