

Flangia di bloccaggio inserti, regolabile in verticale

Caratteristiche tecniche

Azionamento

non azionato

Raffreddamento

esterno

Pressione

20 bar

X [mm]

38

Y [mm]

–

Z [mm]

–

Prodotti INDEX TRAUB

A100 • C42/65 • G160 • ABC • C100
• C200 • G200 • G200.2 • G220 •
G250 • ABC.2

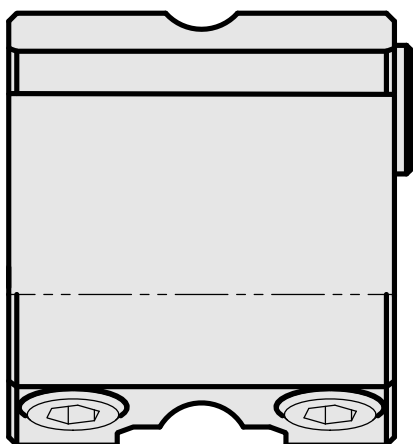
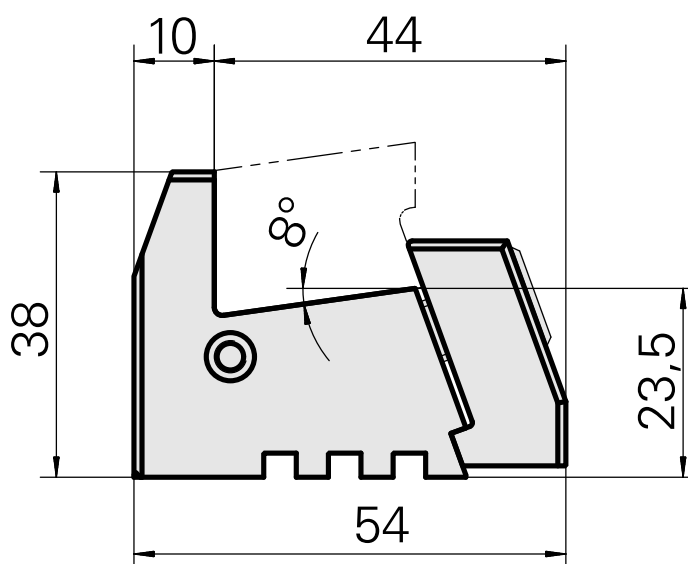
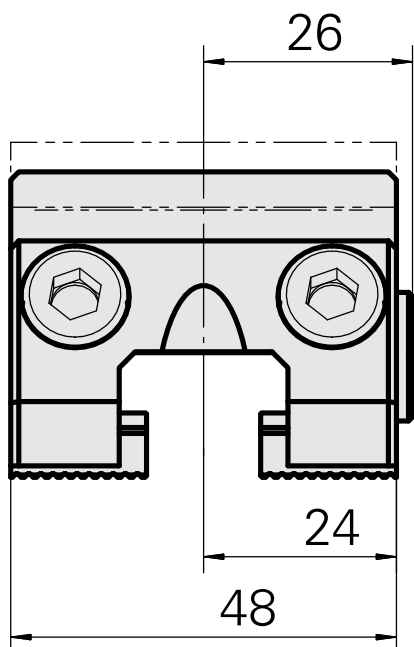
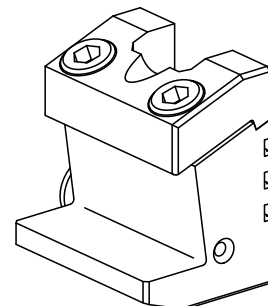

Documenti

Non sono disponibili download per questo prodotto

Accessori

Accessori opzionali

Altri accessori

[Allegato](#)

Id prodotto : 10137275

Id prodotto precedente : W31400.46
