

ER-Collet chuck for taps ET 1-25 7mm

Technical data

TH accessories category	ER-Collet chuck for taps
Mounting	ER25
Tool mounting	7mm
Collet type	ET 1-25

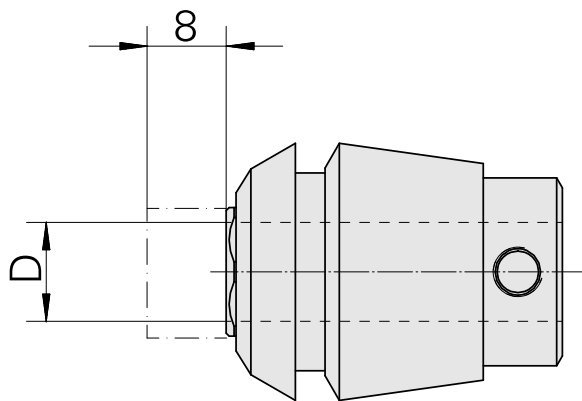

10386926
322465

INDEX

Documents

No downloads available for this product