

Clamping head SK42 D=8,5mm

Technical data

Clamping device size	SK42
manufacturer product line	SPANNTOP nova chuck
Clamping type	smooth
Nominal diameter (mm)	8.5 Millimeter
Clamping method	External clamping
manufacturer product line	Hainbuch

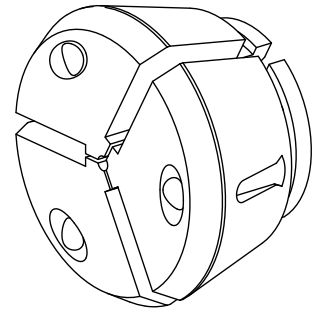

No 3-side view is currently available for this product

Documents

No downloads available for this product