

## Centering drill, center 60°

### Technical data

TH accessories category

Center, universal

Mounting

D15.4/Cone 1:7.5

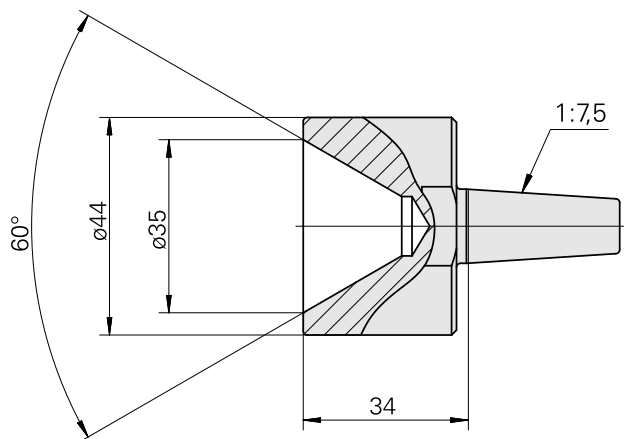
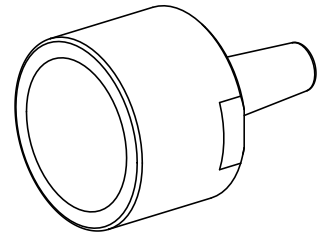

## **Documents**

No downloads available for this product