

Drilling tool holder VDI 30 D16, Form E2

Technical data

| | |
|-----------------------------|--|
| Shank VDI | VDI 30 |
| Drive | not live |
| Fixation VDI | none |
| Cooling | external and internal |
| Pressure | 20 bar |
| Mounting | D16 |
| reversible 180° | no |
| Data carrier | check tool station bore |
| X [mm] | 60 (2.36") |
| Y [mm] | - |
| Z [mm] | - |
| INDEX TRAUB products | V100 • V200 • V160C • V160G • V300 • TNA300 |

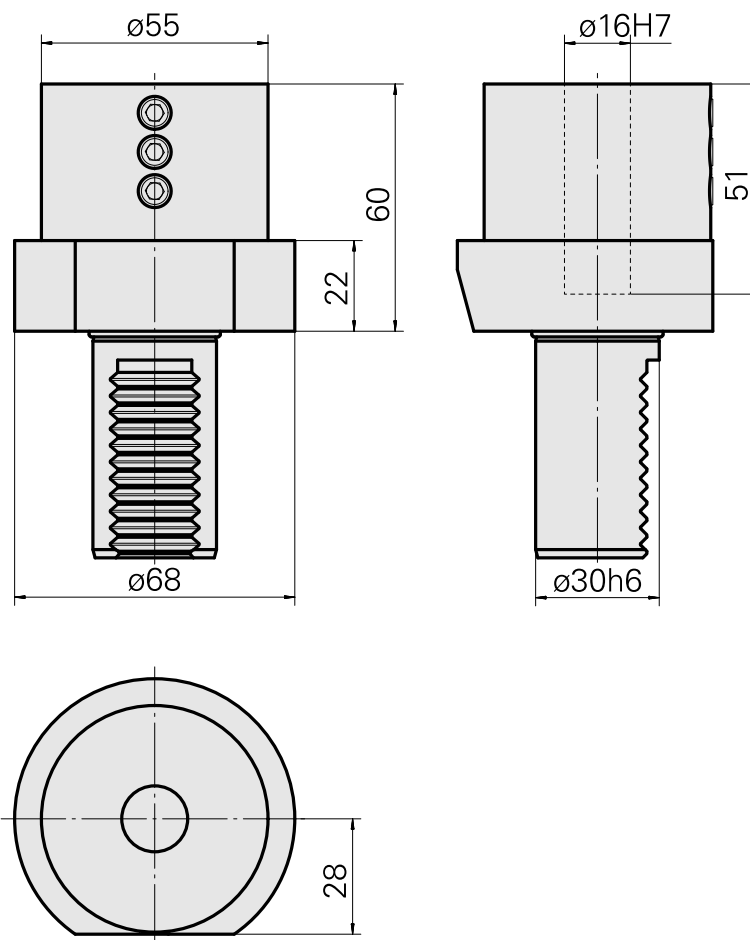
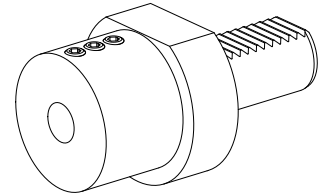

Documents

No downloads available for this product

Accessories

Optional accessories

Other accessories

[Mounting sleeve with collar D16](#)

Product ID : 10914323

Previous product ID : W67511.04--
