

WFB 32-20 D6

Technical data

TH accessories category

WFB 32-20

Mounting

D6

Quick change inserts

Weldon mounting

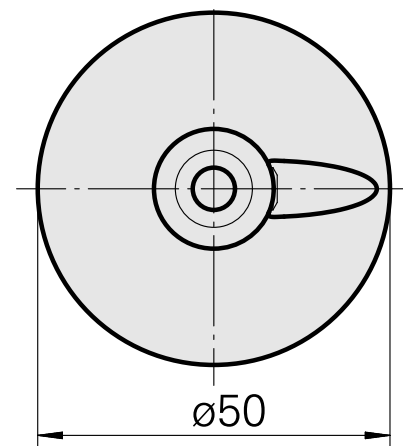
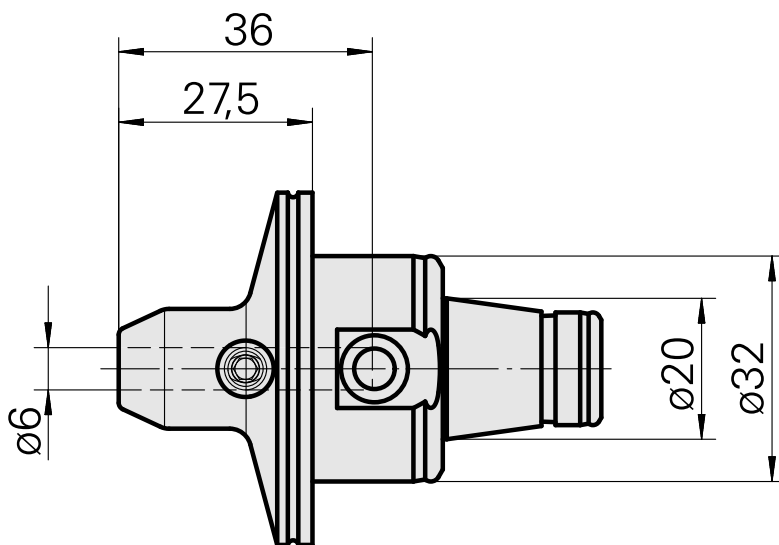
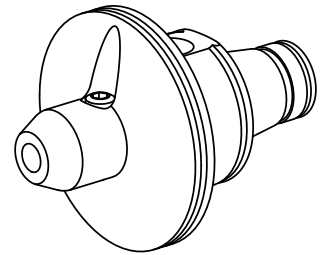

10108972
836270

INDEX

Documents

No downloads available for this product