

Drilling tool holder HSK 50 B50/D50/C40

Technical data

Shank HSK	HSK 50
Form HSK	B50/D50/C40
Mounting	DIN 1835 B/E D5
Cooling	internal
Pressure	40 bar
X [mm]	60 (2.36")
INDEX TRAUB products	G300 • V100 • V200 • G200 • V300

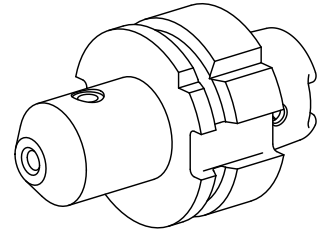

Note

Form B - cooling lubricant is supplied via the collar!

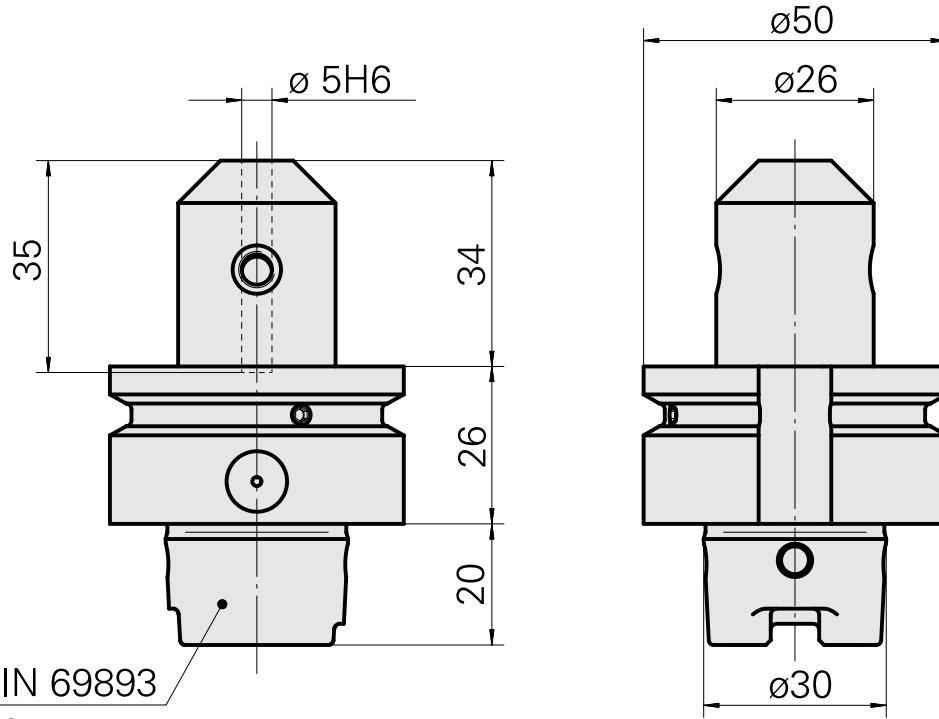

DIN 69893
HSK 50
B50/D50/C40

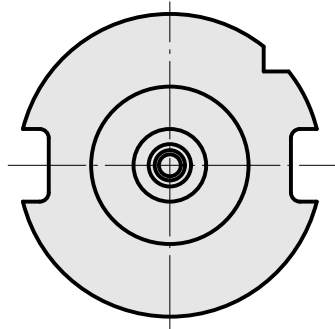

Documents

No downloads available for this product