

## INDEX CAPTO C3 Milling shaft D16, with cutter tightening screw

### Technical data

TH accessories category

INDEX CAPTO C3

Mounting

Milling shaft D16

Quick change inserts

mill arbor mounting

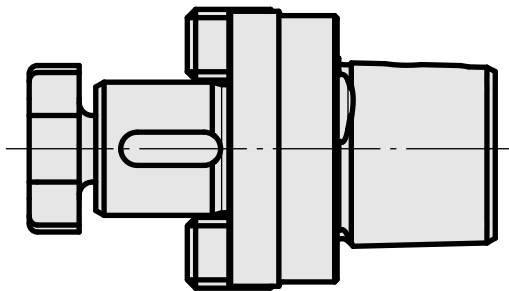
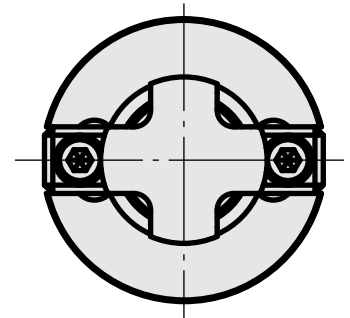
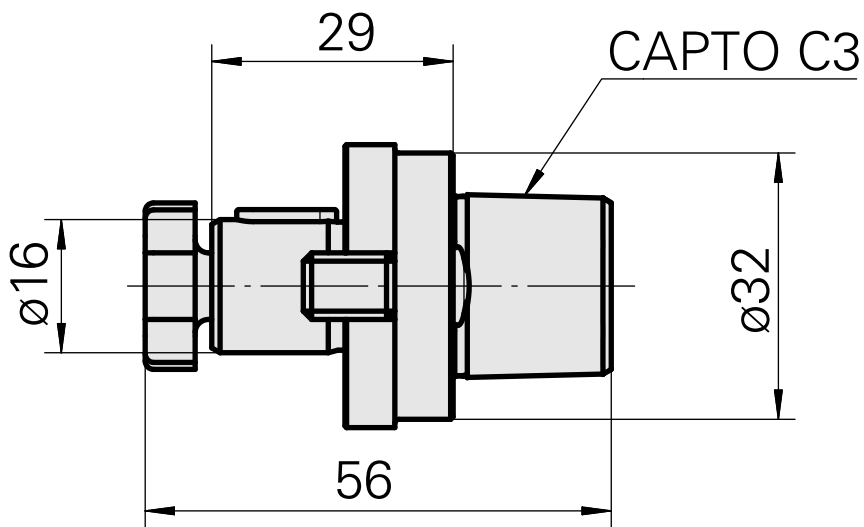
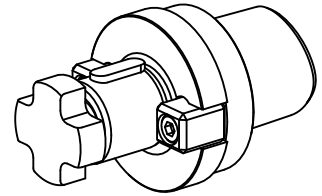

---

## Documents

No downloads available for this product

## Accessories

Required for operation

### [mill arbor wrench](#)

Product ID : 10007866

Previous product ID : 203020.1160

TH accessories  
category  
Tool

Mounting  
Milling shaft D16

Tools for Collet chucks  
Mill arbor wrench

## Optional accessories

### Tool holder accessories

#### [Screw](#)

Product ID : 10381768

Previous product ID : 250122.0820

TH accessories  
category  
Cutter tightening screw

Mounting  
M8