

WFB 32-20 D12

Technical data

TH accessories category

WFB 32-20

Mounting

D12

Quick change inserts

Weldon mounting

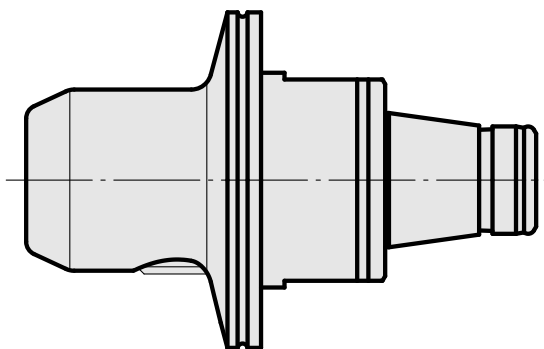
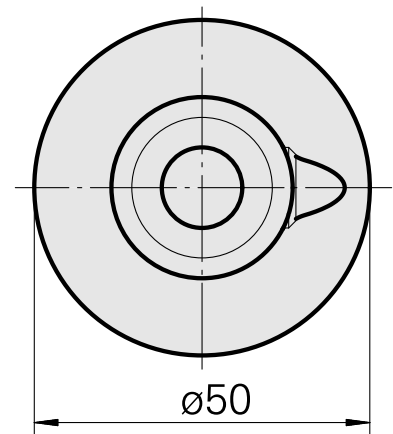
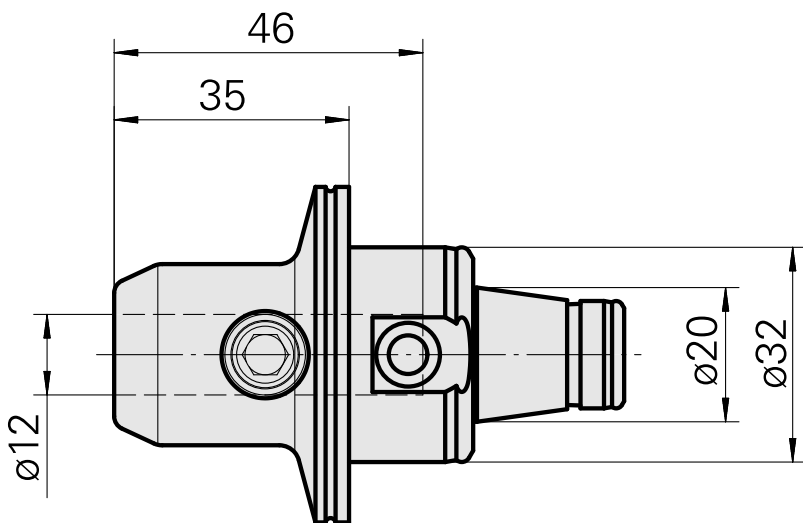
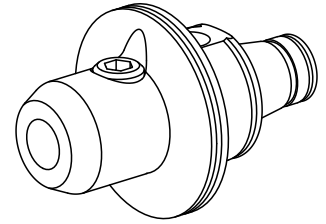

Documents

No downloads available for this product

Accessories

Optional accessories

Other accessories

[Mounting sleeve with collar D12](#)

Product ID : 11060576

Previous product ID : W94280.21--
