

## Guide bush T223 Ø=14,00

### Technical data

Clamping device size	T223
manufacturer product line	
Clamping type	with carbide insert
Nominal diameter (mm)	14 Millimeter
Clamping method	External clamping
Collet design	adjustable
Collet version	S-slot
manufacturer product line	Schlenker

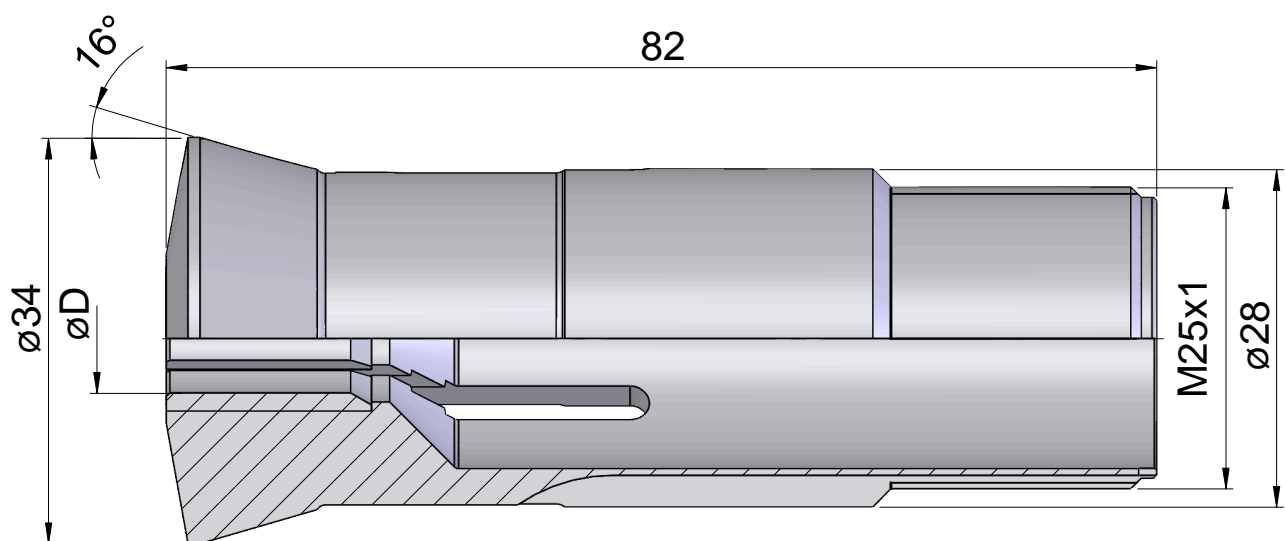

## **Documents**

No downloads available for this product